

1. Technical Specifications

Operation frequency	2.4 GHz - 2.483 GHz
Transmission power	4 dBm
Range (Typical indoor)	10 - 30m
Protocol	Bluetooth® Mesh
Operating voltage	220 - 240VAC 50/60Hz
Stand-by power	<0.65W (Empty load)
Switched power	Max. 40 devices, 80mA
Warming-up	5s
Sensor principle	PIR detection
Detection range (Max.)*	Installation Height : 5m
HBIR29/SV	Detection Range (Ø) : 10m @ 3m height
Detection range (Max.)*	Installation height : 15m (forklift)
HBIR29/SV/H	12m (person)
Detection angle	360°
Operation temperature	Ta: -20°C - +50°C
IP rating	IP20
Standard compliance	EN300328, EN301489-1, EN301489-17, EN62479, EN65015, EN61547, EN60669-1, EN60669-2-1, EN62493
Certification	CB, CE, EMC, RED, RCM



2. Download the App



The access to Silvair apps
mobile app: Silvair on the App Store
web app: platform.silvair.com

3. Detection Range

HBIR29/SV

Lens	Max. Detection	With Blind A	With Blind B
Convex 	Height: 3m Max. range (Ø): 10m	Height: 3m Max. range (Ø): 5m	Height: 3m Max. range (Ø): 8m
Flat 	Height: 3m Max. range (Ø): 9m	Height: 3m Max. range (Ø): 4.5m	Height: 3m Max. range (Ø): 7m

HBIR29/SV/H (Mid Bay)

		Installation height	15m (forklift)
			12m (person)
		Detection range (Ø)	20m

4. Installation

Mechanical Structure & Dimensions

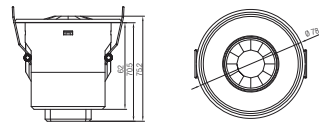
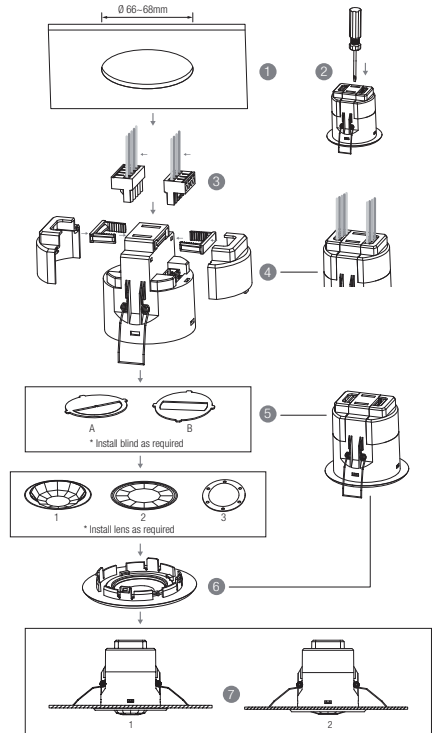

1. Ceiling (drill hole $\varnothing 66-68\text{mm}$)
2. Carefully prise off the cable clamps.
3. Make connections to the pluggable terminal blocks.
4. Insert plug connectors and secure using the provided cable clamps, then clip terminal covers to the base.
5. Fit detection blind (if required) and desired lens.
6. Clip fascia to body.
7. Bend back springs and insert into ceiling.

Wiring Diagram

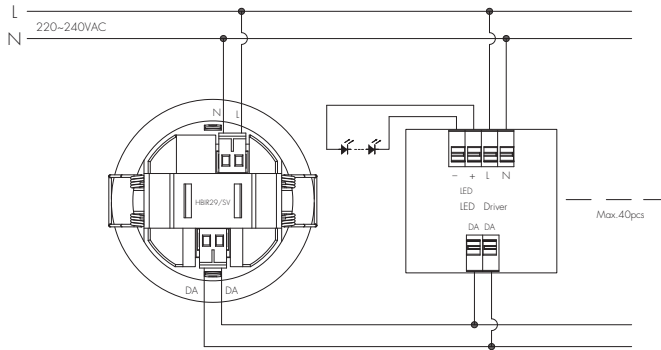

Wire Preparation

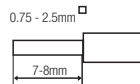

Pluggable screw terminal. It is recommended to make connections to the terminal before fitting to the sensor.

Optional Accessory --- Ceiling/Surface Mount Box: HA03

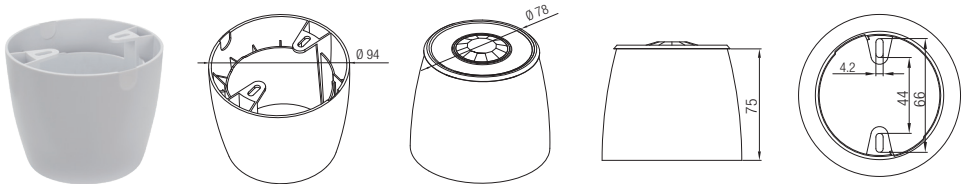

5.Mesh Factory Reset

The device HBR29/SV can be reset by placing a strong magnet (e.g. N38 neodymium magnet, $d=10\text{mm}$ * $h=4\text{mm}$) near the sensor lens for 5 seconds. Once the factory reset is done successfully, the luminaire flashes and then permanent on, then the device is being able to be re-commissioned by SILVAIR app.

6.To Reprovision

Place a strong magnet on the site of the Reset/Hall effect sensor (see diagram 4 below). To trigger the reset the magnet must be held in position for 5 seconds.

Diagram

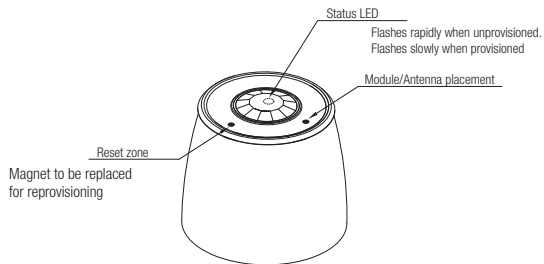

Note: When change the lens part of HBR29/SV, please kindly make sure that the lens fits the right location, where the "Reset dot" and "BLE dot" matches with the physical location on the PCB.

Status LED blinking Sequence

HBR29/SV Unprovisioned	30ms ON	300ms OFF
HBR29/SV Provisioned	15ms ON	2,000ms OFF
Factory reset	500ms ON	1,000ms OFF
Factory reset (initial burst)	100ms ON	1,000ms OFF
MESH package received	30ms ON	50ms OFF
Attention (from network)	500ms ON	500ms OFF

7. Additional Information / Documents

- 1.Regarding precautions for PIR Sensors installation and operation, please kindly refer to www.hytronik.com/download ->knowledge ->PIR Sensors - Precautions for Product Installation and Operation
- 2.Data sheet is subject to change without notice. Please always refer to the most recent release on www.hytronik.com/products/bluetooth technology ->Partnership
- 3.Regarding Hytronik standard guarantee policy, please refer to www.hytronik.com/download ->knowledge ->Hytronik Standard Guarantee Policy