

PIR Standalone Motion Sensor with  Bluetooth® 5.0 SIG Mesh

HBIR29 Low-bay	HBIR29/R Reinforced Low-bay	HBIR29/W Wide range Low-bay
HBIR29/H High-bay	HBIR29/RH Reinforced High-bay	HBIR29/UH Ultra high-bay

HYTRONIK®

































Product Description

HBIR29 series are Bluetooth PIR standalone motion sensors with one DALI channel output (80mA DALI power supply built in). It is ideal for typical indoor applications such as office, classroom, healthcare and other commercial areas. With Bluetooth wireless mesh networking, it makes communication between luminaires much easier without time-consuming hardwiring, which eventually saves costs for projects (especially for retrofit upgrade projects!). Meanwhile, simple device setup and commissioning can be done via **Koolmesh**® app.











App Features

-  Quick setup mode & advanced setup mode
-  Web app/platform for project deployment & data analysis
-  Koolmesh Pro app on iPad for on-site configuration
-  Floorplan feature to simplify project planning
-  coming soon
-  One-key device replacement
-  Device social relations check
-  Staircase function (primary & secondary)
-  Remote control via gateway support HBGW01
-  Heat map
-  Dynamic daylight harvest auto-adaptation
-  Grouping luminaires via mesh network
-  Scenes
-  Dusk/Dawn photocell (Twilight function)
-  Tri-level control
-  Daylight harvest
-  Circadian rhythm (Human centric lighting)
-  Push switch configuration
-  Detailed motion sensor settings
-  Schedule
-  Astro timer (sunrise and sunset)
-  Power-on status (memory against power loss)
-  Offline commissioning

-  Bulk commissioning (copy and paste settings)
-  Different permission levels via authority management
-  Network sharing via QR code or keycode
-  Interoperability with Hytronik Bluetooth product portfolio
-  Compatible with EnOcean BLE switches
-  Internet-of-Things (IoT) featured
-  Device firmware update over-the-air (OTA)
-  Continuous development in progress...

Hardware Features

-  80mA DALI broadcast output
-  Support to control DT8 LED drivers
-  2 Push inputs for flexible manual control
-  Keep real time for up to 3 months against power failure
-  Black & White & Gray metal surface mount box options
-  Two types of blind inserts / blanking plates
-  User-friendly design for installation
-  High bay version available (up to 21m in height)
-  5-year warranty



Fully support EnOcean self-powered switch module PTM215B (HBES01/W & HBES01/B)

Bluetooth 5.0 SIG mesh



for iOS



for Android





for iOS



for Android

Smartphone app for both iOS & Android platform





for iPad

Koolmesh Pro app for iPad





for Web

Web app/platform: www.iot.koolmesh.com

Technical Specifications

Bluetooth Transceiver	
Operation frequency	2.4 GHz - 2.483 GHz
Transmission power	4 dBm
Range (Typical indoor)	10~30m
Protocol	 Bluetooth® 5.0 SIG Mesh

Input & Output Characteristics	
Operating voltage	220~240VAC 50/60Hz
Stand-by power	< 1W
Switched power	Max. 80mA
Warming-up	20s

Sensor Data	
Sensor Model	PIR detection
HBIR29	Installation Height : 6m Detection Range(Ø) : 9m
HBIR29/R	Installation Height : 6m Detection Range(Ø) : 10m
HBIR29/W	Installation Height : 6m Detection Range(Ø) : 18m
HBIR29/H	Installation height: 15m (forklift) 12m (person) Detection range (Ø): 24m
HBIR29/RH	Installation height: 20m (forklift) 12m (person) Detection range (Ø): 40m
HBIR29/UH	Installation height: 21m Detection range (Ø): 28m
Detection angle	360°

Safety & EMC	
EMC standard (EMC)	EN55015, EN61000, EN61547
Safety standard (LVD)	EN60669-1, EN60669-2-1 AS/NZS60669-1/-2-1
RED	EN300328, EN301489-1/-17
Certification	CB, CE, EMC, RED, RCM

Environment	
Operation temperature	Ta: -20°C ~ +50°C
IP rating	IP20

* For more details of detection range, please refer to "detection pattern" section.

Mechanical Structure & Dimensions

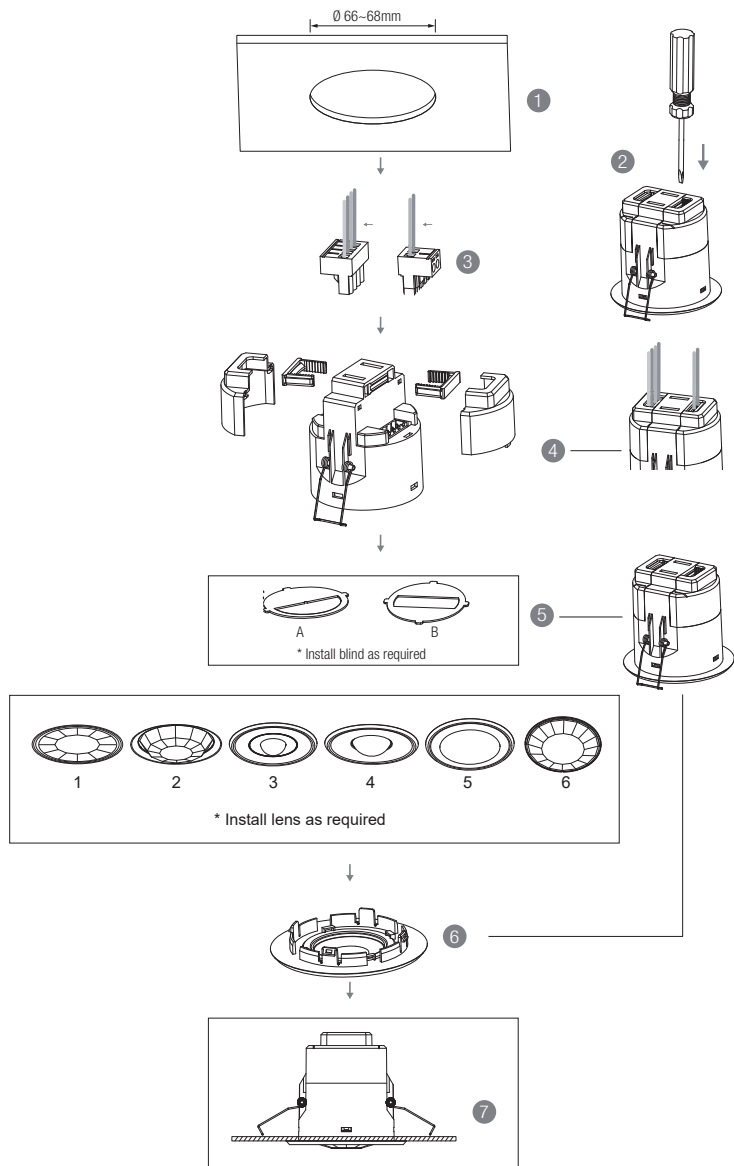

1. Ceiling (drill hole \varnothing 66~68mm)
2. Carefully prise off the cable clamps.
3. Make connections to the pluggable terminal blocks.
4. Insert plug connectors and secure using the provided cable clamps, then clip terminal covers to the base.
5. Fit detection blind (if required) and desired lens.
6. Clip fascia to body (this step is not applicable for /UH).
7. Bend back springs and insert into ceiling.

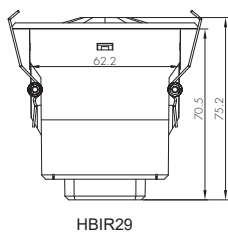
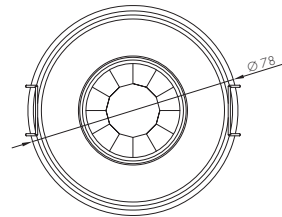

HBIR29

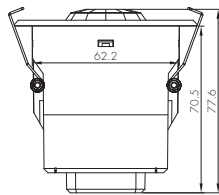

HBIR29/R

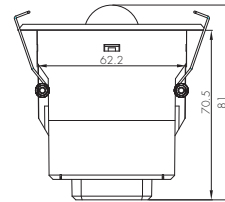

HBIR29/W

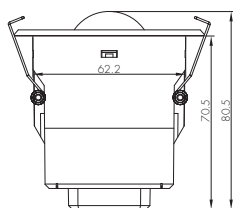

HBIR29/H

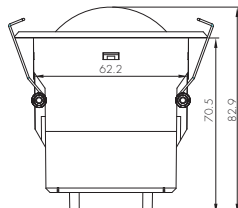

HBIR29/RH

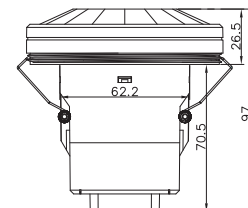

HBIR29/UH

Wiring Diagram

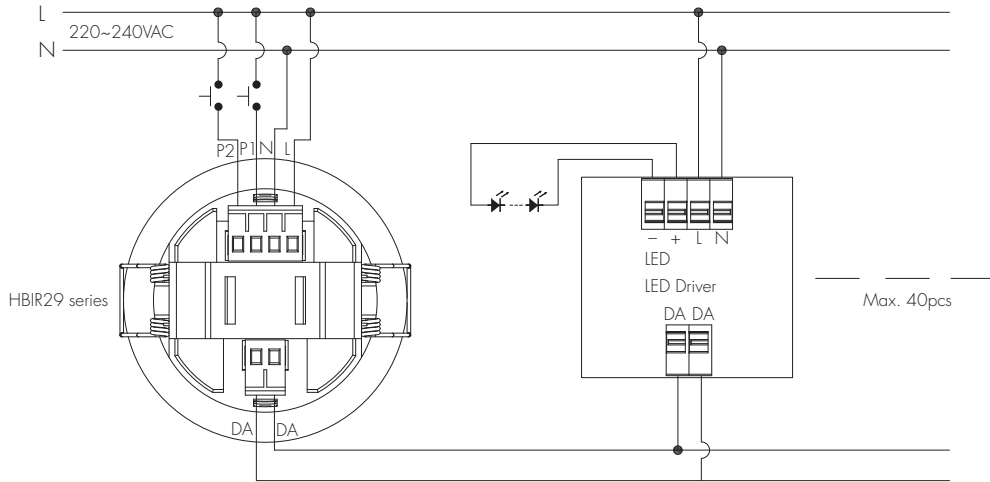

Wire Preparation

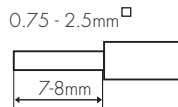

Pluggable screw terminal. It is recommended to make connections to the terminal before fitting to the sensor.

1. 200 metres (total) max. for 1 mm² CSA (Ta = 50°C)
2. 300 metres (total) max. for 1.5 mm² CSA (Ta = 50°C)

Detection Pattern & Optional Accessories

Placement Guide and Typical Range

Smart Phone to Device Range

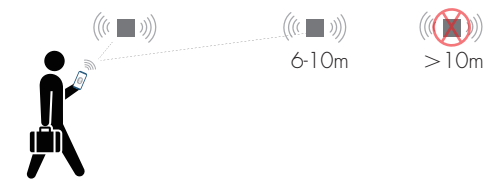

The smart device with the App installed will have a typical range of 10m, but varies from device to device. During commissioning, the installer will need to be in range of the devices when searching for devices to add to the network.

Once the devices have been added to the network via the App, the devices will start communicating within the wireless mesh. This means that once the network is complete, all devices are accessible from the smart device when in a 20m range of a single point.

1. HBIR29 (Low-bay)



HBIR29: Low-bay flat lens detection pattern for **single person** @ $T_a = 20^\circ\text{C}$
 (Recommended ceiling mount installation height **2.5m-6m**)

A: Tangential movement	B: Radial movement	Mount height	Tangential (A)	Radial (B)
		2.5m	max 50m ² (Ø = 8m)	max 13m ² (Ø = 4m)
		3m	max 64m ² (Ø = 9m)	max 13m ² (Ø = 4m)
		4m	max 38m ² (Ø = 7m)	max 13m ² (Ø = 4m)
		5m	max 38m ² (Ø = 7m)	max 13m ² (Ø = 4m)
		6m	max 38m ² (Ø = 7m)	max 13m ² (Ø = 4m)

Optional Accessory -- Ceiling/Surface Metal Mount Box: HA09/W, HA09/B, HA09/G

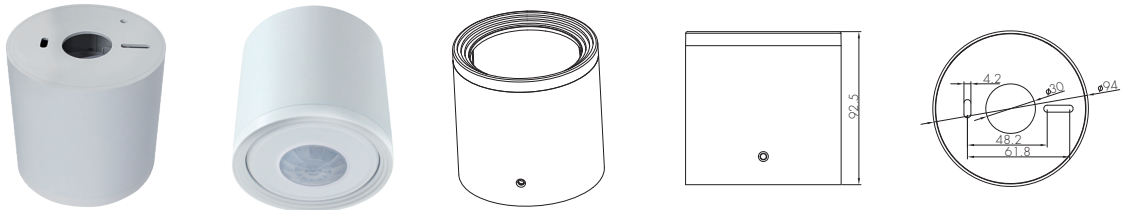

Optional Accessory -- Blind Insert for Blocking Certain Detection Angles

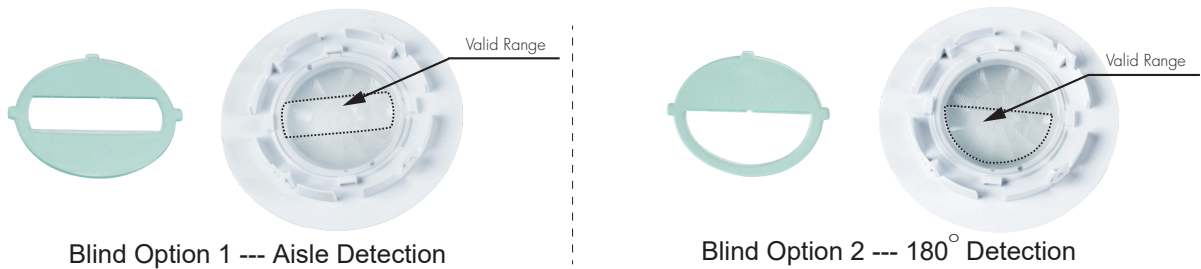

Blind Option 1 --- Aisle Detection

Blind Option 2 --- 180° Detection

2. HBIR29/R (Reinforced Low-bay)



HBIR29/R: Low-bay convex lens detection pattern for **single person** @ $T_a = 20^\circ\text{C}$

(Recommended ceiling mount installation height **2.5m-6m**)

A: Tangential movement	B: Radial movement	Mount height	Tangential (A)	Radial (B)
		2.5m	max 79m ² (Ø = 10m)	max 20m ² (Ø = 5m)
		3m	max 79m ² (Ø = 10m)	max 20m ² (Ø = 5m)
		4m	max 64m ² (Ø = 9m)	max 20m ² (Ø = 5m)
		5m	max 50m ² (Ø = 8m)	max 20m ² (Ø = 5m)
		6m	max 50m ² (Ø = 8m)	max 20m ² (Ø = 5m)

Optional Accessory -- Ceiling/Surface Metal Mount Box: HA09/W, HA09/B, HA09/G

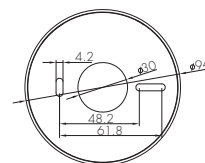
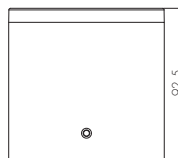
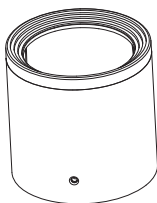

Optional Accessory -- Blind Insert for Blocking Certain Detection Angles

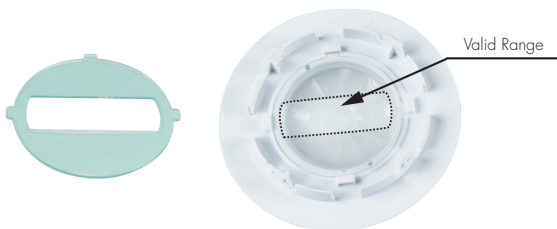

Blind Option 1 --- Aisle Detection

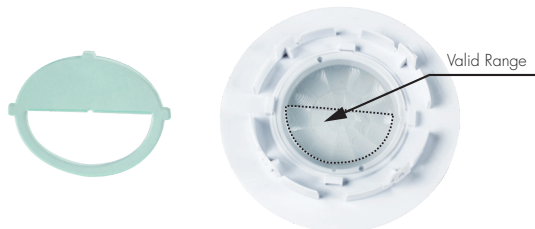

Blind Option 2 --- 180° Detection

3. HBR29/W (Wide range Low-bay)



HBR29/W: Low-bay convex lens detection pattern for **single person** @ $T_a = 20^\circ\text{C}$

(Recommended ceiling mount installation height **2.5m-6m**)

A: Tangential movement	B: Radial movement	Mount height	Tangential (A)	Radial (B)
		2.5m	max 254m ² (Ø = 18m)	max 28m ² (Ø = 6m)
		3m	max 254m ² (Ø = 18m)	max 28m ² (Ø = 6m)
		4m	max 154m ² (Ø = 14m)	max 28m ² (Ø = 6m)
		5m	max 113m ² (Ø = 12m)	max 28m ² (Ø = 6m)
		6m	max 79m ² (Ø = 10m)	max 13m ² (Ø = 4m)

Optional Accessory -- Ceiling/Surface Metal Mount Box: HA09/W, HA09/B, HA09/G

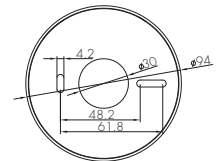
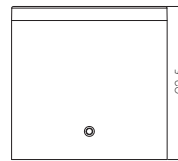

4. HBIR29/H (High-bay)



HBIR29/H: High-bay lens detection pattern for **forklift** @ $T_a = 20^\circ\text{C}$

(Recommended ceiling mount installation height **10m-15m**)

A: Tangential movement	B: Radial movement	Mount height	Tangential (A)	Radial (B)
		10m	max 380m ² (Ø = 22m)	max 201m ² (Ø = 16m)
		11m	max 452m ² (Ø = 24m)	max 201m ² (Ø = 16m)
		12m	max 452m ² (Ø = 24m)	max 201m ² (Ø = 16m)
		13m	max 452m ² (Ø = 24m)	max 177m ² (Ø = 15m)
		14m	max 452m ² (Ø = 24m)	max 133m ² (Ø = 13m)
		15m	max 452m ² (Ø = 24m)	max 113m ² (Ø = 12m)



HBIR29/H: High-bay lens detection pattern for **single person** @ $T_a = 20^\circ\text{C}$

(Recommended ceiling mount installation height **2.5m-12m**)

A: Tangential movement	B: Radial movement	Mount height	Tangential (A)	Radial (B)
		2.5m	max 50m ² (Ø = 8m)	max 7m ² (Ø = 3m)
		6m	max 104m ² (Ø = 11.5m)	max 7m ² (Ø = 3m)
		8m	max 154m ² (Ø = 14m)	max 7m ² (Ø = 3m)
		10m	max 227m ² (Ø = 17m)	max 7m ² (Ø = 3m)
		11m	max 269m ² (Ø = 18.5m)	max 7m ² (Ø = 3m)
		12m	max 314m ² (Ø = 20m)	max 7m ² (Ø = 3m)

Optional Accessory -- Ceiling/Surface Metal Mount Box: HA09/W, HA09/B, HA09/G

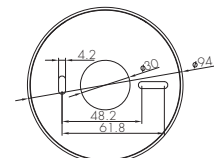
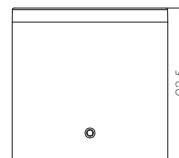

Optional Accessory -- Blind Insert for Blocking Certain Detection Angles

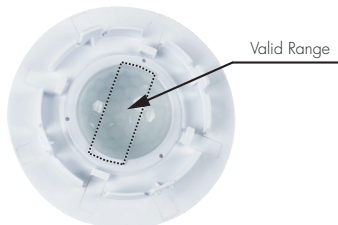

Blind Option 1 --- Aisle Detection

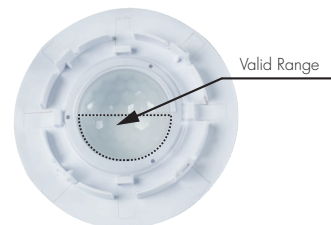

Blind Option 2 --- 180° Detection

5. HBIR29/RH (Reinforced High-bay with 3-Pyro)



HBIR29/RH: Reinforced high-bay lens detection pattern for **forklift** @ $T_a = 20^\circ\text{C}$
(Recommended ceiling mount installation height **10m-20m**)

Mount height	Tangential (A)	Radial (B)
10m	max 346m ² (Ø = 21m)	max 177m ² (Ø = 15m)
11m	max 660m ² (Ø = 29m)	max 177m ² (Ø = 15m)
12m	max 907m ² (Ø = 34m)	max 154m ² (Ø = 14m)
13m	max 962m ² (Ø = 35m)	max 154m ² (Ø = 14m)
14m	max 1075m ² (Ø = 37m)	max 113m ² (Ø = 12m)
15m	max 1256m ² (Ø = 40m)	max 113m ² (Ø = 12m)
20m	max 707m ² (Ø = 30m)	max 113m ² (Ø = 12m)



HBIR29/RH: Reinforced high-bay lens detection pattern for **single person** @ $T_a = 20^\circ\text{C}$
(Recommended ceiling mount installation height **2.5m-12m**)

Mount height	Tangential (A)	Radial (B)
2.5m	max 38m ² (Ø = 7m)	max 7m ² (Ø = 3m)
6m	max 154m ² (Ø = 14m)	max 7m ² (Ø = 3m)
8m	max 314m ² (Ø = 20m)	max 7m ² (Ø = 3m)
10m	max 531m ² (Ø = 26m)	max 13m ² (Ø = 4m)
11m	max 615m ² (Ø = 28m)	max 13m ² (Ø = 4m)
12m	max 707m ² (Ø = 30m)	max 13m ² (Ø = 4m)

Optional Accessory -- Ceiling/Surface Metal Mount Box: HA09/W, HA09/B, HA09/G

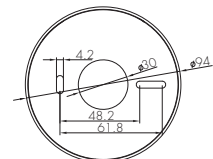
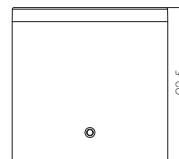

6. HBIR29/UH (Ultra High-bay)



HBIR29/UH: Ultra High-bay convex lens detection pattern for single person @ Ta = 20°C
(Recommended ceiling mount installation height 3m-21m)

Noted: The different humidity levels in the environment can affect the sensor detection range.

Mount height	Tangential (A)	Radial (B)
3m	max12.5m ² (Ø = 4m)	max12.5m ² (Ø = 4m)
6m	max50m ² (Ø = 8m)	max28m ² (Ø = 6m)
9m	max113m ² (Ø = 12m)	max50m ² (Ø = 8m)
12m	max201m ² (Ø = 16m)	max79m ² (Ø = 10m)
15m	max314m ² (Ø = 20m)	max113m ² (Ø = 12m)
18m	max452m ² (Ø = 24m)	max113m ² (Ø = 12m)
21m	max615m ² (Ø = 28m)	max113m ² (Ø = 12m)

A: Tangential movement

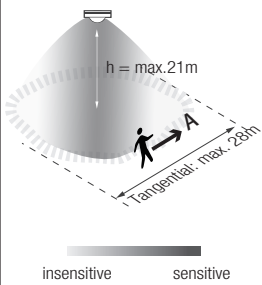

B: Radial movement

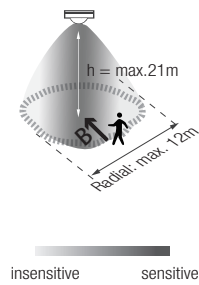

Optional Accessory --- Ceiling/Surface Metal Mount Box: HA09/W, HA09/B, HA09/G

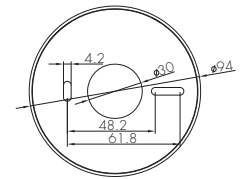
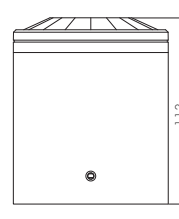
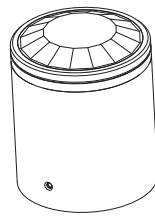

Optional Accessories For Water-Proof

Big and small silicon gasket used to make IP54 degree protection (mounted into HA09 housing for ceiling mount)

Small silicon water-proof gasket dimension(size:mm)

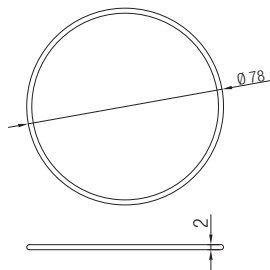

Big silicon water-proof gasket dimension(size:mm)

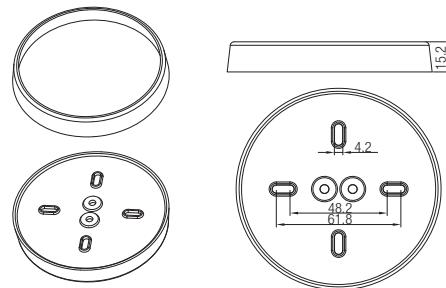

Note: HBIR29/UH is only suitable for small silicon water-proof gasket

Dimming Interface Operation Notes

Switch-Dim

The provided Switch-Dim interface allows for a simple dimming method using commercially available non-latching (momentary) wall switches. Detailed Push switch configurations can be set on Koolmesh app.

Switch Function	Action	Descriptions
Push switch	Short press (<1 second) * Short press has to be longer than 0.1s, or it will be invalid.	- Turn on/off - Recall a scene - Turn on only - Quit manual mode - Turn off only - Do nothing
	Double push	- Turn on only - Quit manual mode - Turn off only - Do nothing - Recall a scene
	Long press (≥1 second)	- Dimming - Colour tuning - Do nothing
Sensorlink	/	- Upgrade a normal on/off motion sensor to a Bluetooth controlled motion sensor
Emergency Self-Test Function	Short press (<1 second) * Short press has to be longer than 0.1s, or it will be invalid.	- Start Self test (Monthly) - Start Self test (Annually) - Stop Self test - Invalid
	Long press (≥1 second)	- Start Self test (Monthly) - Start Self test (Annually) - Stop Self test - Invalid
Fire Alarm (VFC signal only)	Refer to Koolmesh ® App User Manual V2.1	- Able to connect the Fire Alarm system - Once the fire alarm system is triggered, all the luminaries controlled by the Push Switch will enter the preset scene (normally it's full on), after the fire alarm system gives the ending signal, all the luminaries controlled by this Push Switch will revert back to normal status.

Additional Information / Documents

- To learn more about detailed product features/functions, please refer to [www.hytronik.com/download ->knowledge ->Introduction of App Scenes and Product Functions](http://www.hytronik.com/download->knowledge->Introduction%20of%20App%20Scenes%20and%20Product%20Functions)
- Regarding precautions for Bluetooth product installation and operation, please kindly refer to [www.hytronik.com/download ->knowledge ->Bluetooth Products - Precautions for Product Installation and Operation](http://www.hytronik.com/download->knowledge->Bluetooth%20Products%20-%20Precautions%20for%20Product%20Installation%20and%20Operation)
- Regarding precautions for PIR Sensors installation and operation, please kindly refer to [www.hytronik.com/download ->knowledge ->PIR Sensors - Precautions for Product Installation and Operation](http://www.hytronik.com/download->knowledge->PIR%20Sensors%20-%20Precautions%20for%20Product%20Installation%20and%20Operation)
- Data sheet is subject to change without notice. Please always refer to the most recent release on [www.hytronik.com/products/bluetooth technology ->Bluetooth Sensors](http://www.hytronik.com/products/bluetooth%20technology->Bluetooth%20Sensors)
- Regarding Hytronik standard guarantee policy, please refer to [www.hytronik.com/download ->knowledge ->Hytronik Standard Guarantee Policy](http://www.hytronik.com/download->knowledge->Hytronik%20Standard%20Guarantee%20Policy)