

IP65 Zhaga Book18 Motion Sensor (High-bay)

SAM15/RC05

0-10V Dimming Control



Product Description

SAM15/RC05 is a 0-10V signal output motion sensor, with Zhaga connector. It is suitable for high-bay application and all sensor parameters can be programmed through remote controller HRC-05.

Features

- 0-10V output
- 12V constant voltage output
- Zhaga Book 18
- High-bay (up to 15m height)
- 5-year warranty, designed for long lifetime up to 50,000 hours



SAM15/RC05
EU Version

SAM15/RC05
US Version

HRC-05

Technical Specifications

Input & Output Characteristics	
Mains voltage	12VDC
Stand-by power	<0.3W

Environment	
Operation temperature	Ta: -20°C ~ +60°C
IP rating	IP65

Sensor Data	
Sensor principle	High Frequency (microwave)
Operation frequency	5.8GHz +/- 75MHz
Transmission power	<1mW
Detection range (Max.)*	Installation Height : 15m Detection Range(Ø) : 20m @ 8m height
Detection angle	30°~ 150°
Setting adjustments:	
Sensitivity	10% / 50% / 75% / 100%
Hold-time	2s / 30s / 1min / 5min / 10min
Stand-by time	0s / 10s / 1min / 10min / 30min / +∞
Stand-by dimming level	10% / 20% / 30%
Daylight threshold	2lux / 10lux / 50lux / disable

Mechanical Structure & Dimensions

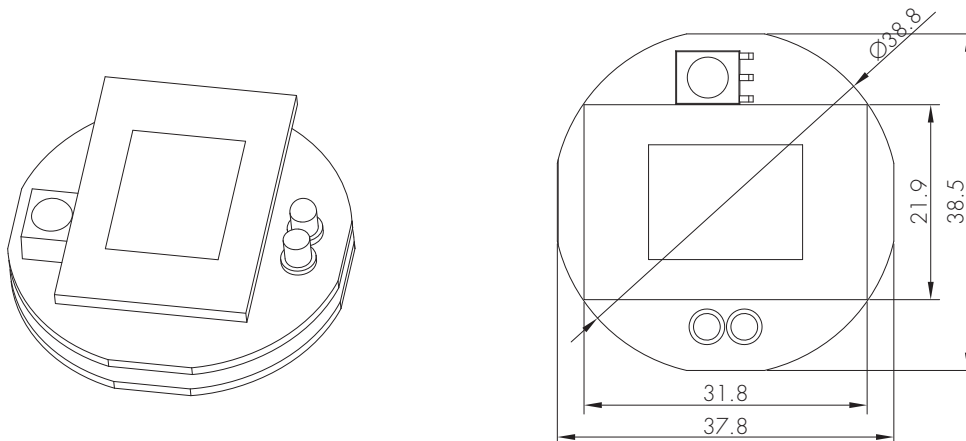

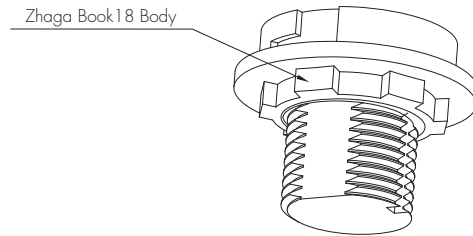
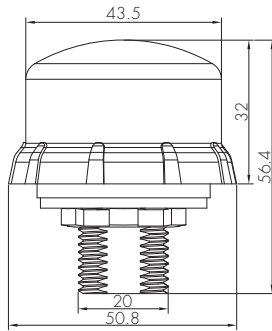
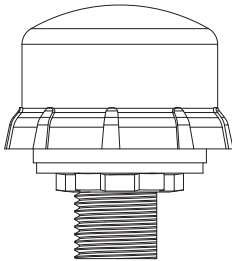
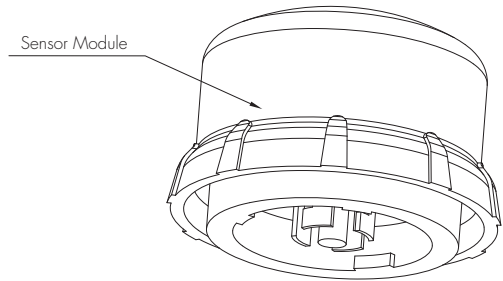
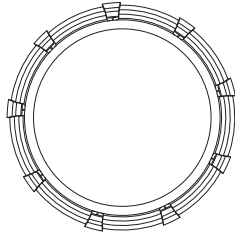
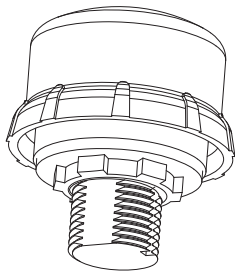

Wiring Diagram

SAM15/RC05
EU Version

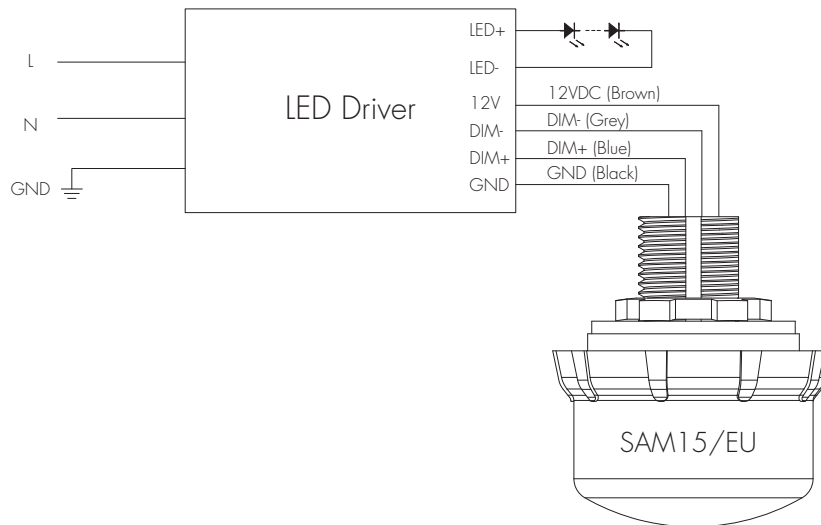

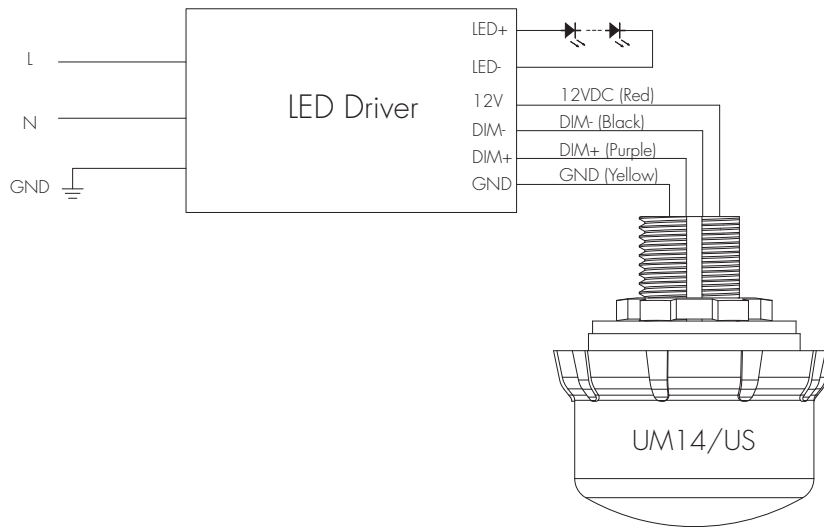

Functions and Features

Tri-level Control (Corridor Function)

Hytronik builds this function inside the motion sensor to achieve tri-level control, for some areas which require a light change notice before switch-off. The sensor offers 3 levels of light: 100%-->dimmed light-->off; and 2 periods of selectable waiting time: motion hold-time and stand-by period; Selectable daylight threshold and freedom of detection area.

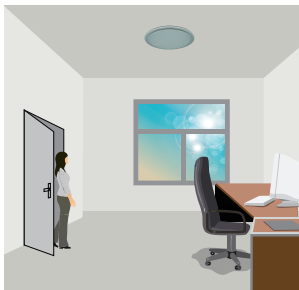

With sufficient natural light, the light does not switch on when presence is detected.

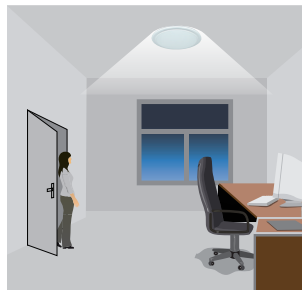

With insufficient natural light, the sensor switches on the light automatically when presence is detected.

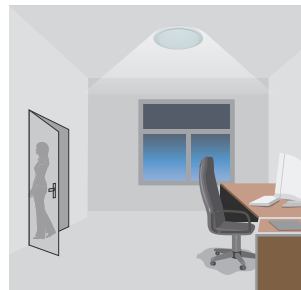

After hold-time, the light dims to level preset.

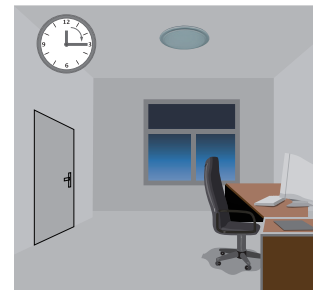

Light switches off automatically after the stand-by period elapses.

Detection Pattern

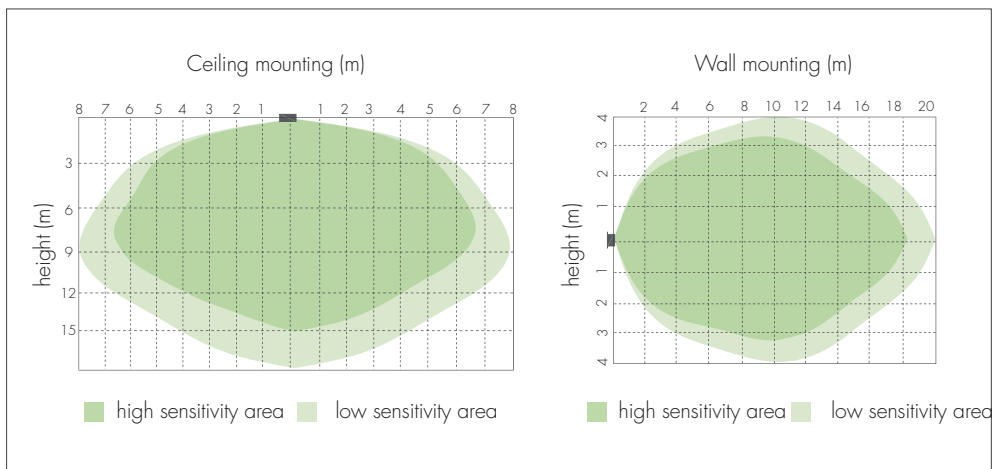

Settings (Remote Control HRC-05)



Permanent ON/OFF function

Press the "ON/OFF" button, the light goes to permanent on or permanent off mode, and the sensor is disabled.

* Press "Auto Mode", "RESET" or "Scene mode" buttons to quit this mode. The mode will change to AUTO Mode after power failure.

Auto Mode

Sensor mode

Press "Auto Mode" button, the sensor starts to function and all settings remain the same as the latest status before the light is switched on/off.



Reset function

Press "RESET" button, all settings go back to default settings.



Dim +/-

Long press "Dim +" or "Dim -" to adjust the target lux level during hold-time. "+" means increasing the target, "-" means decreasing the target.



Test mode

This button is for testing purpose only. The sensor goes to test mode (hold-time is 2s) after commissioning, meanwhile the stand-by period and daylight sensor are disabled.

* This mode can be ended by pressing "reset", or any button of "scene mode" and "hold-time". The sensor settings are changed accordingly.



Power output

By pressing these two buttons, the output shifts between 80% (at initial 10,000 hours) and 100%, for energy saving purpose.



Lux disable

Press this button, the built-in daylight sensor stops working, and all motion detected could turn on the lighting fixture, no matter how bright the natural light is.

Scene mode

There are 4 scene modes fixed program built in the remote control to choose for different applications:

Scene options	Detection range	Hold-time	Stand-by period	Stand-by dimming level	Daylight sensor
SC1	100%	1min	10min	10%	2Lux
SC2	100%	5min	10min	10%	2Lux
SC3	100%	10min	30min	10%	10Lux
SC4	100%	10min	+∞	10%	50Lux

* End-user can adjust the settings by pressing buttons of detection range/hold-time/stand-by period/stand-by dimming level/daylight sensor. The last setting stays in validity.

Detection range

Press the buttons of "detection range" to set detection range at 10% /50% /100%.

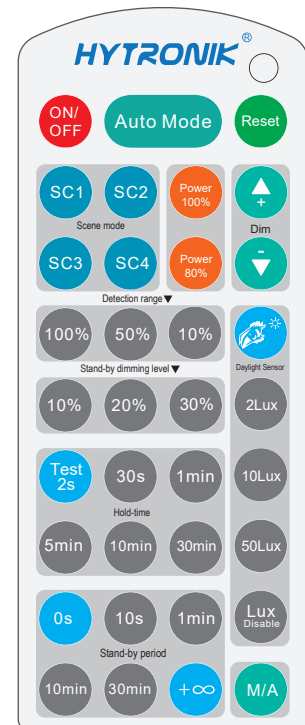

HRC-05

Note: the light will flash ONCE rapidly after receiving the command from the remote control successfully.

Hold-time

Press the buttons of "hold-time" to set hold-time at 2s / 30s / 1min / 5min / 10min.

Daylight sensor

Press the buttons of "daylight sensor" to set daylight threshold at 2Lux / 10Lux / 50Lux. The fixture will not turn on if ambient natural light lux level exceeds the threshold preset when motion detected.

Stand-by period (corridor function)

Press the buttons of "stand-by period" to set stand-by period at 0s / 10s / 1min / 10min / 30min / +∞.
* "0s" means on/off control; "+∞" means bi-level dimming control, and the fixture never switches off.

Stand-by dimming level

Press the buttons of "stand-by dimming level" to set the stand-by dimming level at 10% / 20% / 30%.

Additional Information / Documents

1. Regarding precautions for microwave sensor installation and operation, please kindly refer to [www.hytronik.com/download ->knowledge ->Microwave Sensors - Precautions for Product Installation and Operation](http://www.hytronik.com/download->knowledge->Microwave+Sensors+-+Precautions+for+Product+Installation+and+Operation)
2. Regarding Hytronik standard guarantee policy, please refer to [www.hytronik.com/download ->knowledge ->Hytronik Standard Guarantee Policy](http://www.hytronik.com/download->knowledge->Hytronik+Standard+Guarantee+Policy)