

1. Technical Specifications

Operation frequency	2.4 GHz - 2.483 GHz
Transmission power	7 dBm
Range (Typical indoor)	10-30m
Protocol	Bluetooth® 5.0 SIG Mesh
Operating voltage	220-240VAC 50/60Hz
Stand-by power	<1W
Load ratings	300VA(capacitive),400W(resistive)
Warming-up	20s
Sensor principle	High Frequency (microwave)
Detection range (Max.)*	Max installation height: 6m Max detection range: 10m (diameter)
Detection angle	30°-150°
Operation temperature	Ta: -20°C~+50°C
Case temperature(MAX.)	Tc: +75°
IP rating	IP20
EMC standard (EMC)	EN55015, EN61000, EN61547 EN60669-1/-2-1
Safety standard (LVD)	AS/NZS60669-1/-2-1
RED	EN300328, EN301489-1/-17, EN62479,
Certification	Semko, CB, CE, EMC, RED, RCM, UKCA

2. Download the App

Free App for set-up and commissioning

Bluetooth 5.0 SIG mesh

iOS 10.0 or later

Android 5.0 or later

Web app/platform:
iat.koolmesh.com

3. Installation

Mechanical Structure & Dimensions

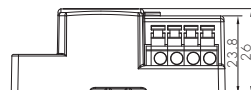
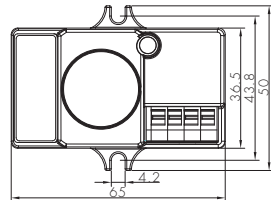
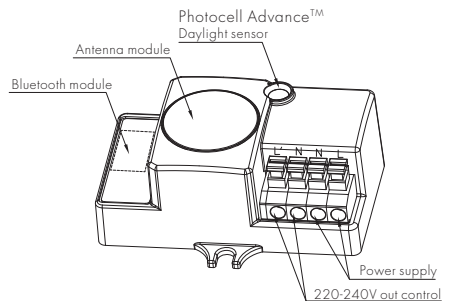
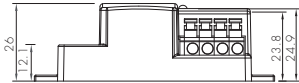
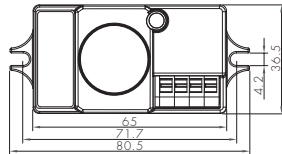
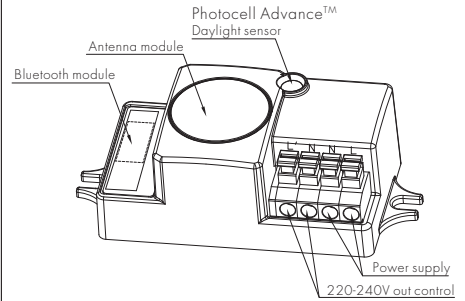

Wire Preparation

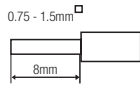

To make or release the wire from the terminal, use a screwdriver to push down the button.

Wiring Diagram

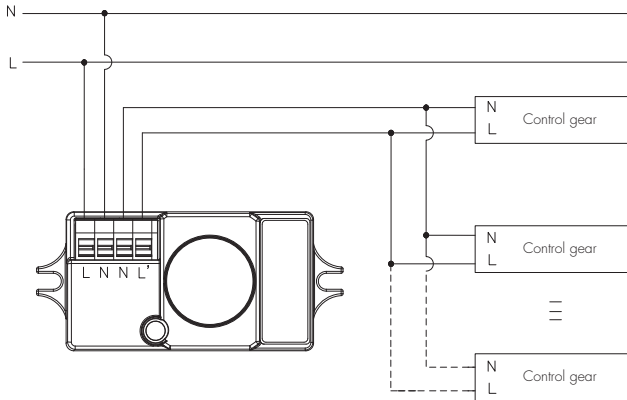

Optional accessory: Reinforced Bluetooth antenna

For some special Applications, customers may need a larger Bluetooth transmission for both smartphone to device and device to device. Thanks to the reinforced Bluetooth antenna, with it being added to the sensor, the transmission distance (smartphone to device) enlarges to 20m, the distance of device to device is around 50m.

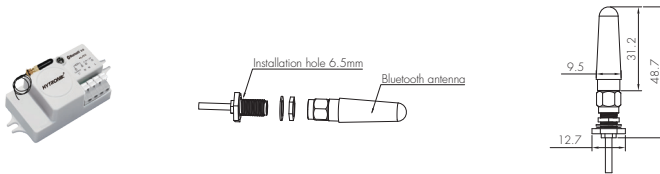

4. Detection Pattern

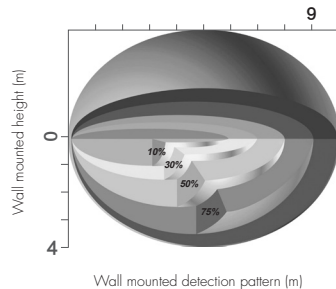
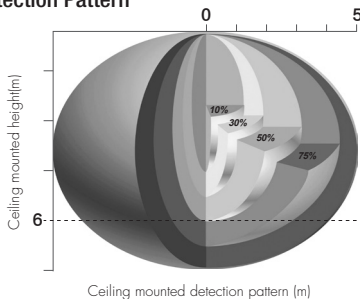

5. Additional Information / Documents

1. For full explanation of Hytronik Photocell Advance™ technology, please kindly refer to www.hytronik.com/download ->knowledge ->Introduction of Photocell Advance
2. To learn more about detailed product features/functions, please refer to www.hytronik.com/download ->knowledge ->Introduction of App Scenes and Product Functions
3. Regarding precautions for Bluetooth product installation and operation, please kindly refer to www.hytronik.com/download ->knowledge ->Bluetooth Products - Precautions for Product Installation and Operation
4. Regarding precautions for microwave sensor installation and operation, please kindly refer to www.hytronik.com/download ->knowledge ->Microwave Sensors - Precautions for Product Installation and Operation
5. Data sheet is subject to change without notice. Please always refer to the most recent release on www.hytronik.com/products/bluetooth technology ->Bluetooth Sensors
6. Regarding Hytronik standard guarantee policy, please refer to www.hytronik.com/download ->knowledge ->Hytronik Standard Guarantee Policy

www.hytronik.com

HYTRONIK®