

1. Technical Specifications

Operation frequency	2.4 GHz - 2.483 GHz
Transmission power	4 dBm
Range (Typical indoor)	10–30m
Protocol	Bluetooth® Mesh
Operating voltage	220–240VAC 50/60Hz
Stand-by power	<0.65W (Empty load)
Switched power	Max. 40 devices, 80mA
Warming-up	5s
Sensor principle	PIR detection
Detection range (Max.)* HBR29/SV	Installation Height : 6m Detection Range (Ø) : 9m
Detection range (Max.)* HBR29/SV/R	Installation Height : 6m Detection Range (Ø) : 10m
Detection range (Max.)* HBR29/SV/H	Installation height : 15m (forklift) 12m (person) Detection range (Ø) : 24m
Detection range (Max.)* HBR29/SV/RH	Installation height : 20m (forklift) 12m (person) Detection range (Ø) : 40m
Detection angle	360°
Operation temperature	Ta: -20°C – +50°C
IP rating	IP20
Standard compliance	EN300328, EN301489-1, EN301489-17, EN62479, EN55015, EN61547, EN60669-1, EN60669-2-1, EN62493
Certification	CB, CE, EMC, RED, RCM

3. Installation

Mechanical Structure & Dimensions

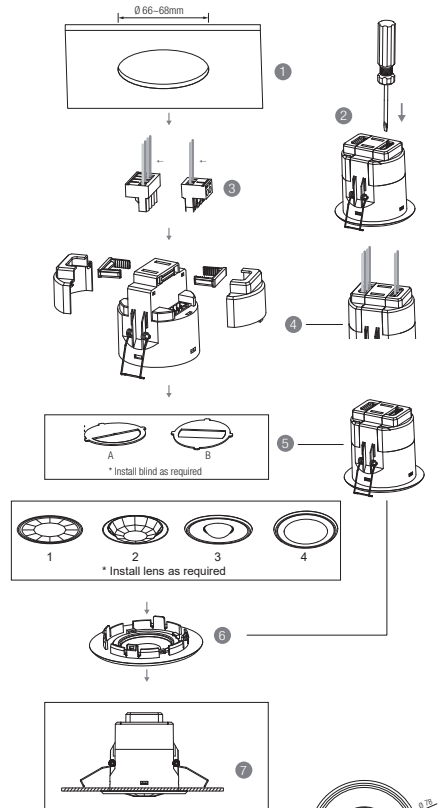

1. Ceiling (drill hole $\varnothing 66-68\text{mm}$)
2. Carefully prise off the cable clamps.
3. Make connections to the pluggable terminal blocks.
4. Insert plug connectors and secure using the provided cable clamps, then clip terminal covers to the base.
5. Fit detection blind (if required) and desired lens.
6. Clip fascia to body.
7. Bend back springs and insert into ceiling.

2. Download the App



The access to Silvoir apps

mobile app: Silvoir on the App Store
web app: platform.silvoir.com

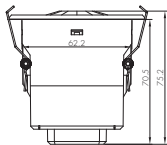

HBR29/SV



HBR29/SV/R

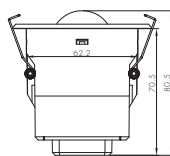

HBR29/SV/H

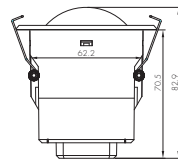

HBR29/SV/RH

Wire Preparation



0.75 - 2.5mm [□]

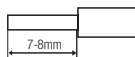

Pluggable screw terminal. It is recommended to make connections to the terminal before fitting to the sensor.

- 1. 200 metres (total) max. for 1mm² CSA (Ta = 50°C)
- 2. 300 metres (total) max. for 1.5mm² CSA (Ta = 50°C)

Wiring Diagram

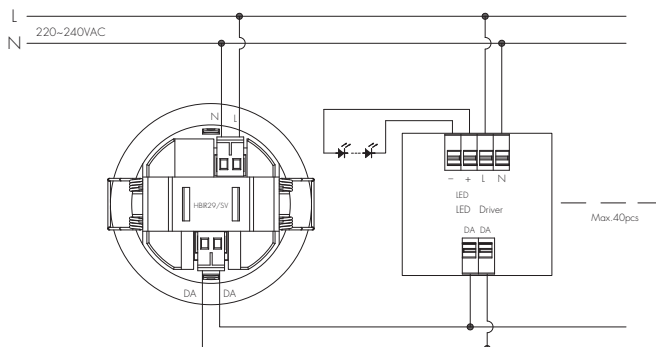

4. Mesh Factory Reset

The device HBR29/SV can be reset by placing a strong magnet (e.g. N38 neodymium magnet, d=10mm* \bar{h} =4mm) near the sensor lens for 5 seconds. Once the factory reset is done successfully, the luminaire flashes and then permanent on, then the device is being able to be re-commissioned by SILVAIR app.

Status LED blinking Sequence		
HBR29/SV Unprovisioned	30ms ON	300ms OFF
HBR29/SV Provisioned	15ms ON	2,000ms OFF
Factory reset	500ms ON	1,000ms OFF
Factory reset (initial burst)	100ms ON	1,000ms OFF
MESH package received	30ms ON	50ms OFF
Attention (from network)	500ms ON	500ms OFF

5.To Reprovision

Place a strong magnet on the site of the Reset/Hall effect sensor (see diagram 4 below). To trigger the reset the magnet must be held in position for 5 seconds.

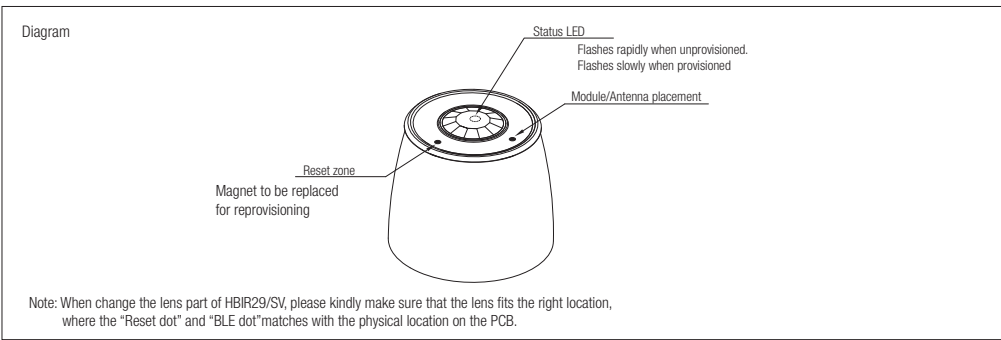

Big and small silicon gasket used to make IP54 degree protection when HBR29/SV series device mounted into HA03 housing for ceiling mount

Small silicon water-proof gasket dimension(size:mm)

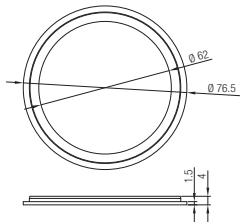

Big silicon water-proof gasket dimension(size:mm)

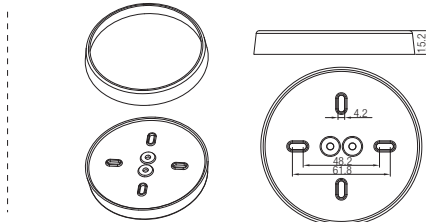

Placement Guide and Typical Range

Smart Phone to Device Range

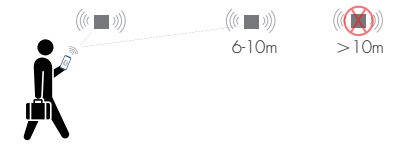

The smart device with the App installed will have a typical range of 10m, but varies from device to device. During commissioning, the installer will need to be in range of the devices when searching for devices to add to the network.

Once the devices have been added to the network via the App, the devices will start communicating within the wireless mesh. This means that once the network is complete, all devices are accessible from the smart device when in a 20m range of a single point.

6. Detection Pattern & Optional Accessories

1. HBIR29/SV (Low-bay)



HBIR29/SV: Low-bay flat lens detection pattern for **single person** @ Ta = 20°C
(Recommended ceiling mount installation height **2.5m-6m**)

A: Tangential movement	B: Radial movement	Mount height	Tangential (A)	Radial (B)
		2.5m	max 50m ² (Ø = 8m)	max 13m ² (Ø = 4m)
		3m	max 64m ² (Ø = 9m)	max 13m ² (Ø = 4m)
		4m	max 38m ² (Ø = 7m)	max 13m ² (Ø = 4m)
		5m	max 38m ² (Ø = 7m)	max 13m ² (Ø = 4m)
		6m	max 38m ² (Ø = 7m)	max 13m ² (Ø = 4m)

Optional Accessory --- Ceiling/Surface Mount Box: HA03

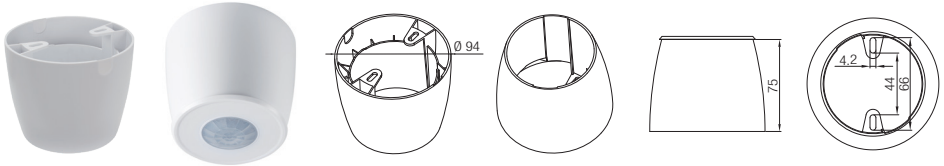

Optional Accessory --- Blind Insert for Blocking Certain Detection Angles

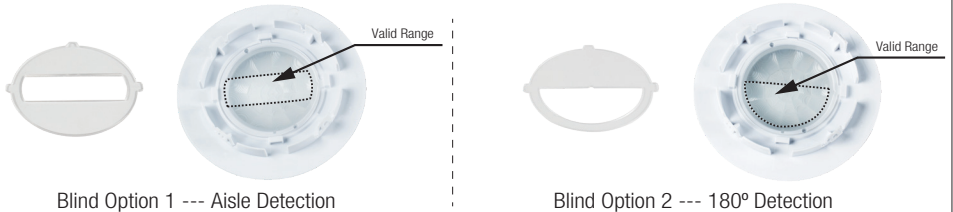

2. HBIR29/SV/R (Reinforced Low-bay)



HBIR29/SV/R: Low-bay convex lens detection pattern for **single person** @ Ta = 20°C
(Recommended ceiling mount installation height **2.5m-6m**)

A: Tangential movement

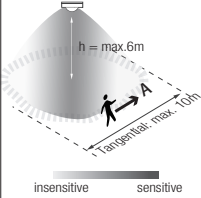

B: Radial movement

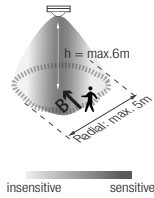

Mount height

Tangential (A)

Radial (B)

2.5m

max 79m² (Ø = 10m)

max 20m² (Ø = 5m)

3m

max 79m² (Ø = 10m)

max 20m² (Ø = 5m)

4m

max 64m² (Ø = 9m)

max 20m² (Ø = 5m)

5m

max 50m² (Ø = 8m)

max 20m² (Ø = 5m)

6m

max 50m² (Ø = 8m)

max 20m² (Ø = 5m)

Optional Accessory --- Ceiling/Surface Mount Box: HA03

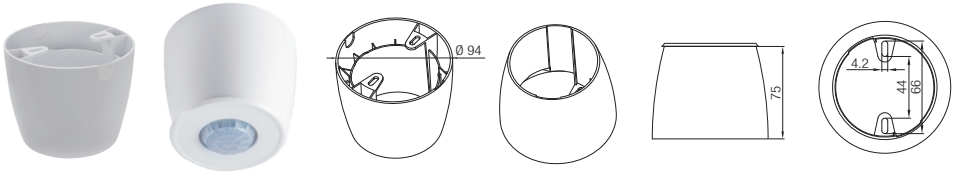

Optional Accessory --- Blind Insert for Blocking Certain Detection Angles

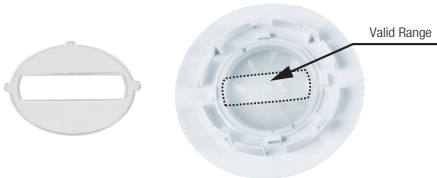

Blind Option 1 --- Aisle Detection



Blind Option 2 --- 180° Detection

3. HBIR29/SV/H (High-bay)



HBIR29/SV/H: High-bay lens detection pattern for **forklift** @ Ta = 20°C
(Recommended ceiling mount installation height **10m-15m**)

A: Tangential movement

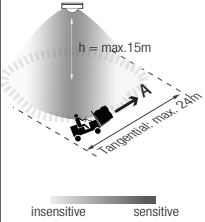

B: Radial movement

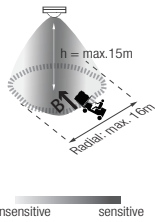

Mount height	Tangential (A)	Radial (B)
10m	max 380m ² (Ø = 22m)	max 201m ² (Ø = 16m)
11m	max 452m ² (Ø = 24m)	max 201m ² (Ø = 16m)
12m	max 452m ² (Ø = 24m)	max 201m ² (Ø = 16m)
13m	max 452m ² (Ø = 24m)	max 177m ² (Ø = 15m)
14m	max 452m ² (Ø = 24m)	max 133m ² (Ø = 13m)
15m	max 452m ² (Ø = 24m)	max 113m ² (Ø = 12m)



HBIR29/SV/H: High-bay lens detection pattern for **single person** @ Ta = 20°C
(Recommended ceiling mount installation height **2.5m-12m**)

A: Tangential movement

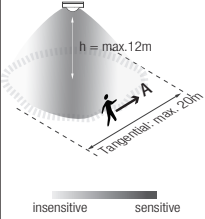

B: Radial movement

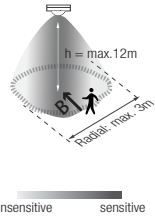

Mount height	Tangential (A)	Radial (B)
2.5m	max 50m ² (Ø = 8m)	max 7m ² (Ø = 3m)
6m	max 104m ² (Ø = 11.5m)	max 7m ² (Ø = 3m)
8m	max 154m ² (Ø = 14m)	max 7m ² (Ø = 3m)
10m	max 227m ² (Ø = 17m)	max 7m ² (Ø = 3m)
11m	max 269m ² (Ø = 18.5m)	max 7m ² (Ø = 3m)
12m	max 314m ² (Ø = 20m)	max 7m ² (Ø = 3m)

Optional Accessory --- Ceiling/Surface Mount Box: HA03

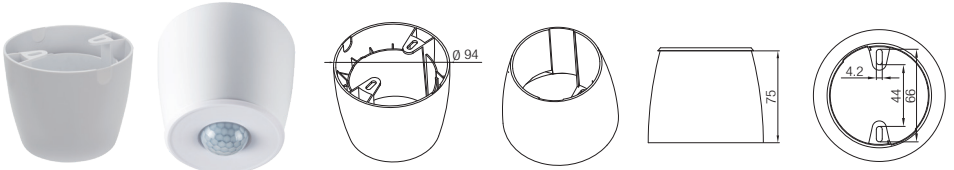

Optional Accessory --- Blind Insert for Blocking Certain Detection Angles

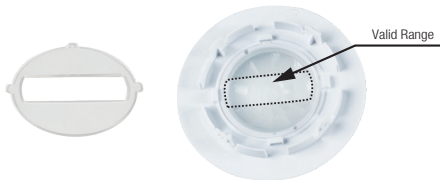

Blind Option 1 --- Aisle Detection

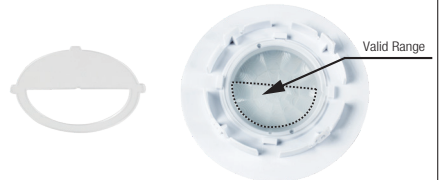

Blind Option 2 --- 180° Detection

4. HBIR29/SV/RH (Reinforced High-bay with 3-Pyro)

HBIR29/SV/RH: Reinforced high-bay lens detection pattern for **forklift** @ Ta = 20°C
(Recommended ceiling mount installation height **10m-15m**)

		Mount height	Tangential (A)	Radial (B)
<p>A: Tangential movement</p>	<p>B: Radial movement</p>	10m	max 346m ² (Ø = 21m)	max 177m ² (Ø = 15m)
		11m	max 660m ² (Ø = 29m)	max 177m ² (Ø = 15m)
		12m	max 907m ² (Ø = 34m)	max 154m ² (Ø = 14m)
		13m	max 962m ² (Ø = 35m)	max 154m ² (Ø = 14m)
		14m	max 1075m ² (Ø = 37m)	max 113m ² (Ø = 12m)
		15m	max 1256m ² (Ø = 40m)	max 113m ² (Ø = 12m)
		20m	max 707m ² (Ø = 30m)	max 113m ² (Ø = 12m)

HBIR29/SV/RH: Reinforced high-bay lens detection pattern for **single person** @ Ta = 20°C
(Recommended ceiling mount installation height **2.5m-12m**)

		Mount height	Tangential (A)	Radial (B)
<p>A: Tangential movement</p>	<p>B: Radial movement</p>	2.5m	max 38m ² (Ø = 7m)	max 7m ² (Ø = 3m)
		6m	max 154m ² (Ø = 14m)	max 7m ² (Ø = 3m)
		8m	max 314m ² (Ø = 20m)	max 7m ² (Ø = 3m)
		10m	max 531m ² (Ø = 26m)	max 13m ² (Ø = 4m)
		11m	max 615m ² (Ø = 28m)	max 13m ² (Ø = 4m)
		12m	max 707m ² (Ø = 30m)	max 13m ² (Ø = 4m)

Optional Accessory --- Ceiling/Surface Mount Box: HA03

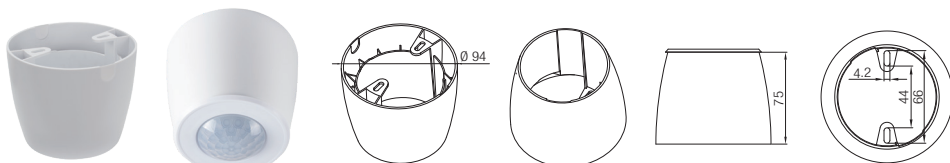

7. Additional Information / Documents

- 1.Regarding precautions for PIR Sensors installation and operation, please kindly refer to www.hytronik.com/download ->knowledge ->PIR Sensors - Precautions for Product Installation and Operation
- 2.Data sheet is subject to change without notice.Please always refer to the most recent release on www.hytronik.com/products/bluetooth technology ->Partnership
- 3.Regarding Hytronik standard guarantee policy, please refer to www.hytronik.com/download ->knowledge ->Hytronik Standard Guarantee Policy