

## Product Description

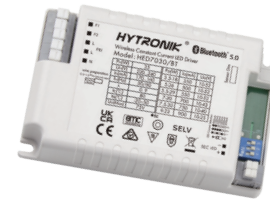













HED7030/BT is a Bluetooth dimmable LED driver, with maximum power output of 30W. It come with Switch-Dim interface by using Push switch (retractive switch) and of course Bluetooth dimming interface. The driver comes with an RJ12 terminal, ready to plug in a wide selection of motion sensors, ranging from HF to PIR, from low bay to high bay etc. It is ideal for direct projects or new luminaires design for lighting manufacturers. With Bluetooth wireless mesh networking, it makes communication between luminaires much easier without time-consuming hardwiring, which eventually saves costs for projects. Meanwhile, simple device setup and commissioning can be done via **Koolmesh®** app.



## App Features

-  Quick setup mode & advanced setup mode
-  Floorplan feature to simplify project planning
-  Web app/platform for dedicated project management
-  Koolmesh Pro iPad version for on-site configuration
-  Grouping luminaires via mesh network
-  Scenes
-  Detailed motion sensor settings
-  Push switch configuration
-  Schedule to run scenes based on time and date
-  Astro timer (sunrise and sunset)
-  Staircase function (primary & secondary)
-  Internet-of-Things (IoT) featured
-  Device firmware update over-the-air (OTA)
-  Device social relations check
-  Bulk commissioning (copy and paste settings)
-  Power-on status (memory against power loss)
-  Offline commissioning
-  Different permission levels via authority management
-  Network sharing via QR code or keycode
-  Remote control via gateway support HBGW01
-  Interoperability with Hytronik Bluetooth product portfolio
-  Compatible with EnOcean switch EWSSB/EWSDB
-  Continuous development in progress...

## Hardware Features

-  Switch-Dim
-  PWM 1KHz (1-100%)
-  Bluetooth dimmable control
-  Insulated terminal cover with cord restraint
-  Standby power <0.5W
-  Active PFC design
-  Logarithmic Dimming
-  Linear Dimming
-  Configurable constant current (CC) output via DIP switch
-  Loop-in and loop-out terminals for efficient installation
-  Open-circuit Protection
-  Short-circuit Protection
-  Overload Protection
-  5-year warranty

\* Certain scenes which require external photocell can be achieved by using together with Hytronik Bluetooth sensors, such as HBIR29, HCDO38/BT + sensor head etc.



Fully support EnOcean self-powered switch module PTM215B (HBES01/W & HBES01/B)

**Bluetooth® 5.0 SIG mesh**

for iOS

for Android

Smartphone app for both iOS & Android platform

---

for iPad

Koolmesh Pro app for iPad

---

Web

for Web

Web app/platform: [www.iot.koolmesh.com](http://www.iot.koolmesh.com)

### Output Configuration

900mA	● ● ● ●	
750mA	○ ● ● ●	
700mA	● ● ● ○	
550mA	○ ● ● ○	
500mA	● ● ○ ○	
350mA	○ ○ ○ ○	
	1 2 3	

Warning: Please make sure the correct current is selected before starting the driver!

### Technical Specifications

Bluetooth Transceiver	
Operation frequency	2.4 GHz - 2.483 GHz
Transmission power	4 dBm
Range (Typical indoor)	10~30m
Protocol	Bluetooth® 5.0 SIG Mesh

Input	
Mains Voltage	220~240VAC 50/60Hz
Mains Current	0.17~0.16A
Power Factor	0.9
Max. Efficiency	86%

Output	
Output Current	350mA~900mA
Output Voltage	10-57V
Uout Max.	75V
Turn-on Time	<0.5s
Dimming Interface	Switch-Dim

Environment	
Operation Temp.	-20 ~ +50°C
Case Temp. (Max.)	80°C
IP Rating	IP20

Safety and EMC	
EMC Standard	EN55015, EN61547, EN6100-2/3, EN300328, EN301489-1/-17, EN62479
Safety Standard	EN61347-1, EN61347-2-13
Dielectric strength	Input→output: 3000VAC / 5mA / 1min
Abnormal protection	Output short-circuit protection Overload Protection Open-circuit Protection

Max. output power/current/voltage range	
HED7030/BT	3.5-20W/350mA / 10-57V
	5-29W/500mA / 10-57V
	5.5-30W/550mA / 10-55V
	7-30W/700mA / 10-43V
	7.5-30W/750mA / 10-40V
	9-23W/900mA / 10-25V

## Mechanical Structure & Dimensions

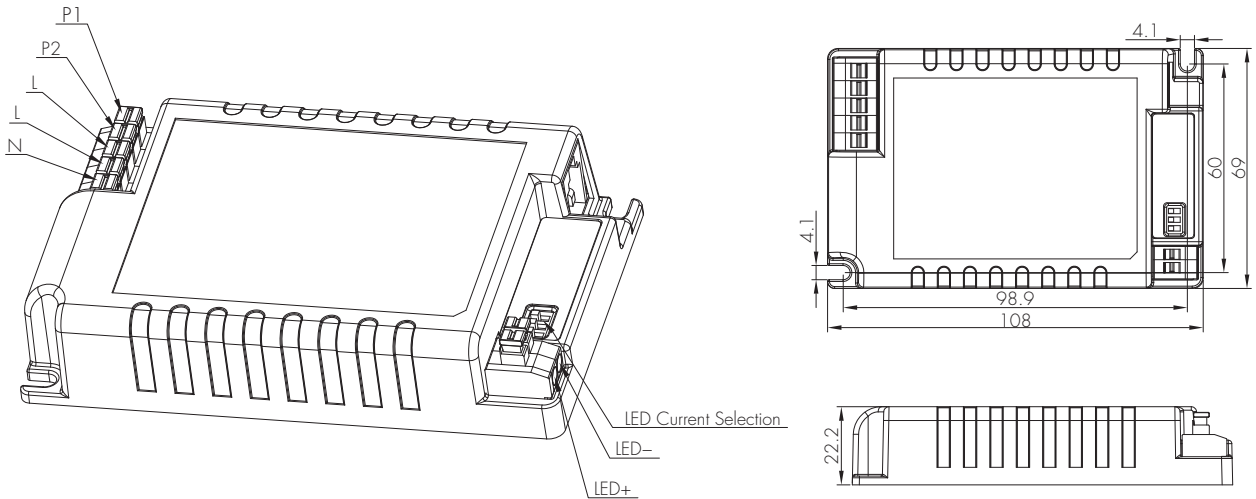

## Wire Preparation

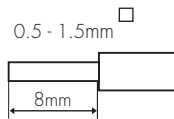
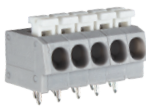

To make or release the wire from the terminal, use a screwdriver to push down the button.

## Wiring Diagram

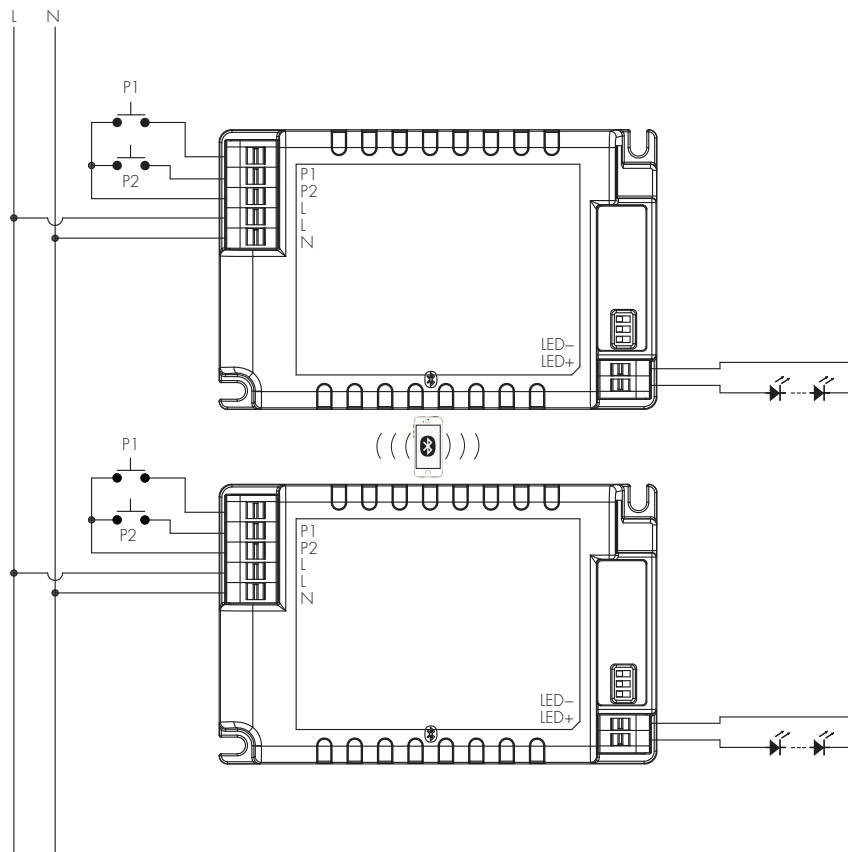

Note: There is no need for any hardwiring on "push" terminal between one driver to another. The installer only needs to connect the push switches to the nearest driver to save labor and cost. The push switches can be assigned to control any Bluetooth driver through the app commissioning.

## Loading and In-rush Current

Model	HEC7030/BF
In-rush Current (Imax.)	38A
Pulse Time	35 $\mu$ s

## Circuit Breaker Information

Automatic circuit breaker type	B16A	B10A	B13A	B20A	B25A
HED7030/BT	54	34	43	67	84

The data above is calculated according to the formula: Maximum Amount =  $16 / (P_n / 230)$ . In order to provide a more reliable reference in real application, the data have been revised to take 60% of the number calculated, i.e.  $16 / (P_n / 230) \times 60\%$ . Please kindly take note that the calculation is based on ABB circuit breaker series S200. Actual values may differ due to different types of circuit breaker used and installation environment.

## Performance Characteristics

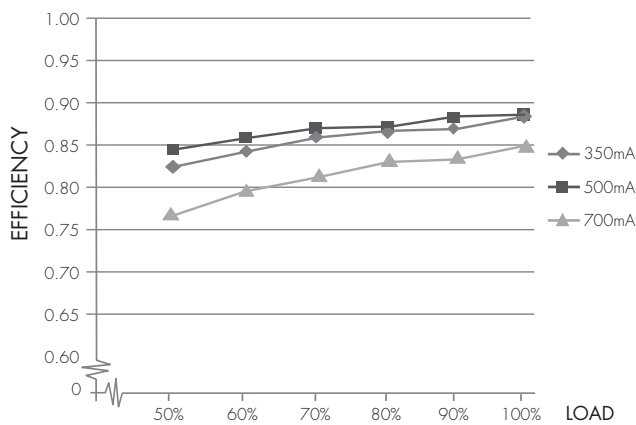

\* Typical Efficiency vs Load

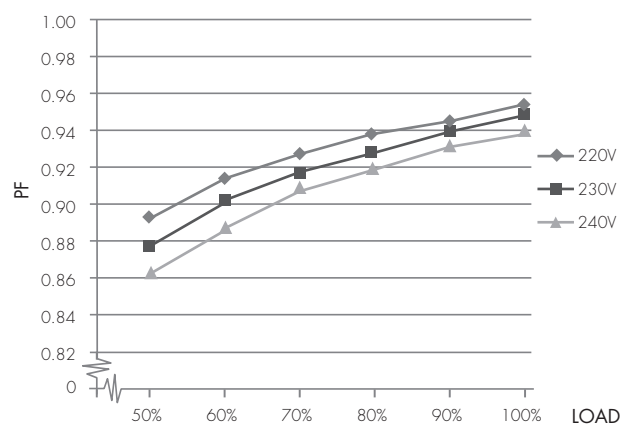

\* Typical Power Factor vs Load

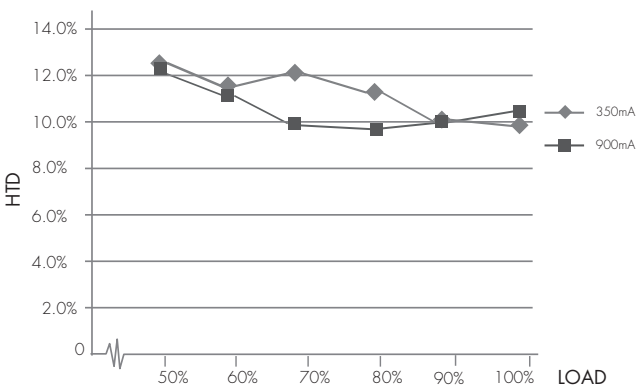

\* Total harmonic distortion vs Load

Note:  
1. Input voltage: 230VAC.

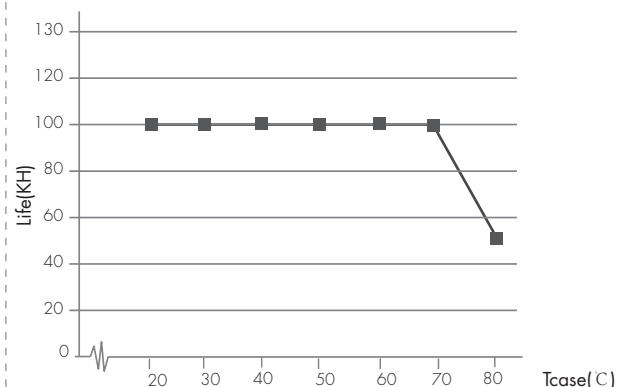

\* Life span vs Tcase (C)

Note:  
1. LED driver's design lifespan is based on a 90% survival rate condition (depicted in the graph).  
2. The relative relationship between the Tc temperature and Ta temperature depends on the luminaire's design.

## Dimming Characteristics

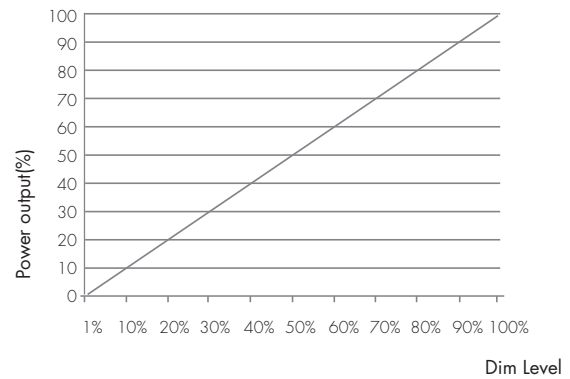
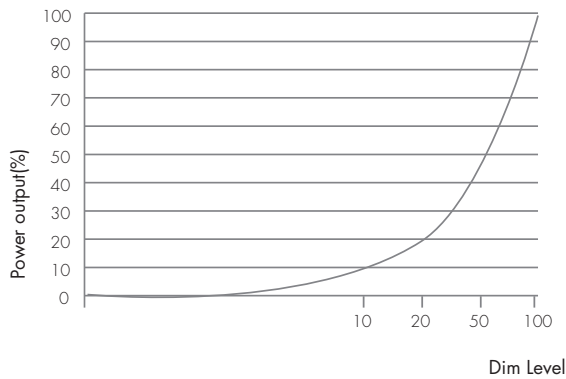

## Technical Specifications for Sensor Heads

PIR Sensor Properties	
Sensor principle	PIR detection
Operating voltage	5VDC
Detection range *	HIRO5 & HIRO5/FM & HIRO5/E & HIRO7 Max installation height: 3m Max detection range: 6m (diameter)
	HIR11 Max installation height: 15m (forklift) 12m (single person) Max detection range: 24m (diameter)
	HIR12 Max installation height: 15m (forklift) 12m (single person) Max detection range: 18m * 6m (L * W)

HF Sensor Properties	
Sensor principle	High Frequency (microwave)
Operating voltage	5VDC
Operation frequency	5.8GHz +/- 75MHz
Transmission power	<0.2mW
Detection range *	SAM20 / SAM21 / SAM22 Max installation height: 3m Max detection range: 12m (diameter)
	SAM23 Max installation height: 12m Max detection range: 16m (diameter)

\* The detection range is heavily influenced by sensor placement (angle) and different walking paces. It may be reduced under certain conditions.

## PIR & microwave sensor heads

The range of PIR and microwave sensor heads below offers powerful number of Plug'n'Play feature options to expand the flexibility of luminaire design. This approach to luminaire design reduces space requirements and component costs whilst simplifying production.

### A. HIRO5

PIR sensor head  
The cable length is around 65cm.

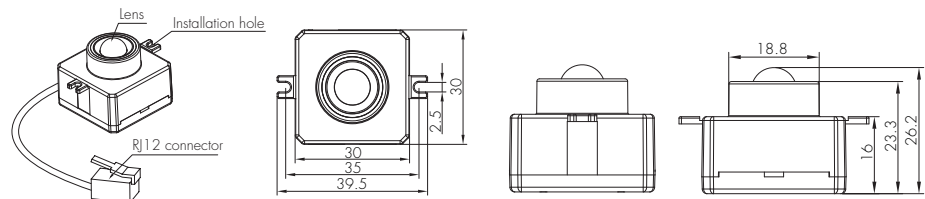

### B. HIRO5/E

PIR sensor head  
The cable length is around 65cm.

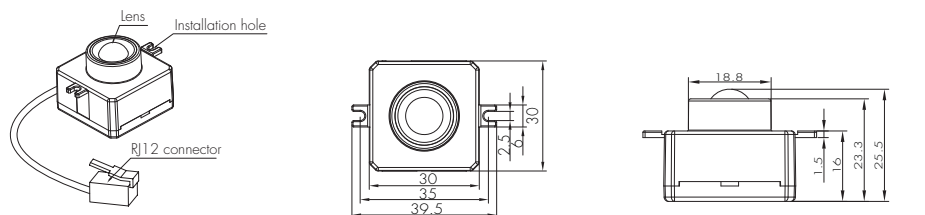

**C. HIRO5/FM**  
 PIR sensor head  
 The cable length is around 65cm.

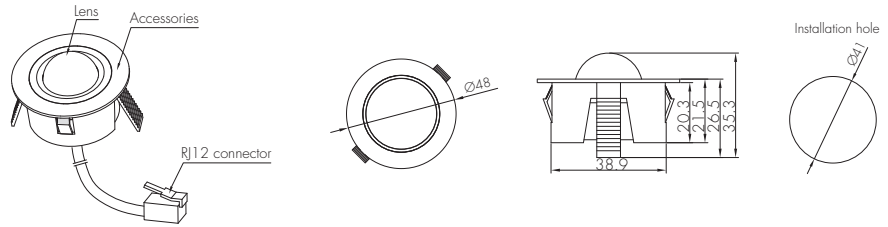

**D. HIRO7**  
 PIR sensor head  
 Photocell Advance™  
 The cable length is around 30cm.

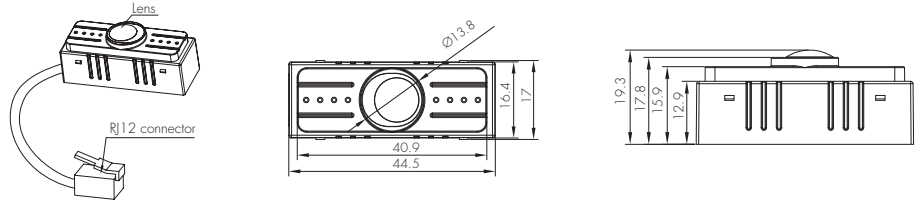

**E. HIR11/S**  
 PIR sensor head  
 Surface mounting  
 For highbay application  
 IP65 (facia / lens part)  
 The cable length is around 65cm.

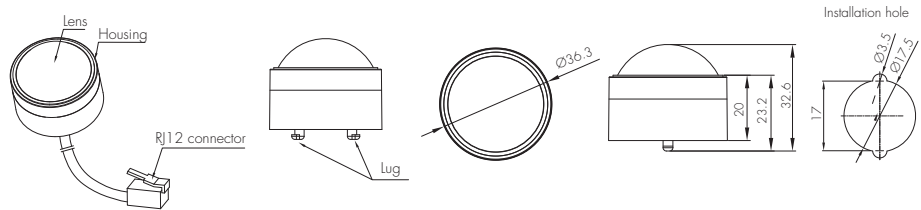

**F. HIR11/F**  
 PIR sensor head  
 Flush mounting  
 For highbay application  
 IP65 (facia / lens part)  
 The cable length is around 65cm.

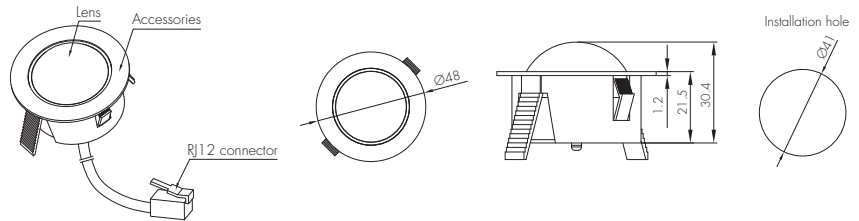

**G. HIR11/C**  
 PIR sensor head  
 Screw to the luminaire by conduit  
 For highbay application  
 IP65 (facia / lens part)  
 The cable length is around 65cm.

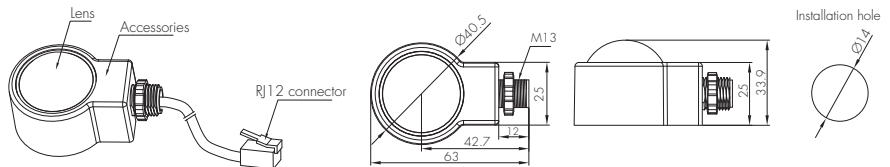

**F. HIR12**  
 PIR sensor head  
 For highbay application  
 IP65 (facia / lens part)  
 The cable length is around 65cm.

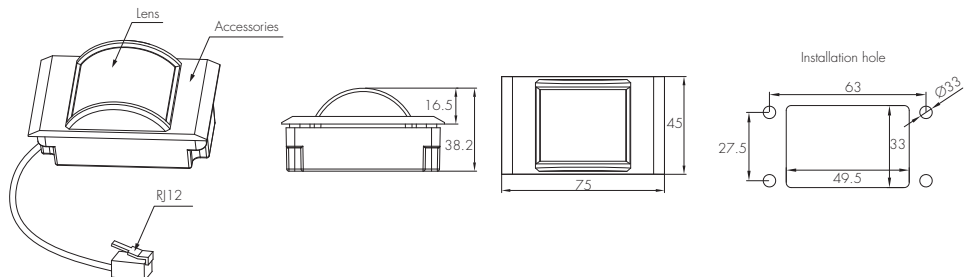

**Installation for HIR12**



We suggest that the metal plate thickness to be 0.8mm - 1.6mm to ensure perfect focal length for the PIR lens.

**I. SAM20**

HF sensor head  
 Photocell Advance™  
 The cable length is around 30cm.

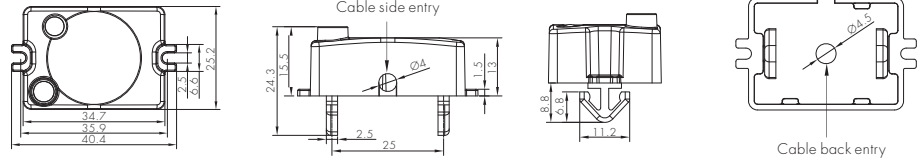

**J. SAM21**

HF sensor head  
 IP65  
 The cable length is around 65cm.

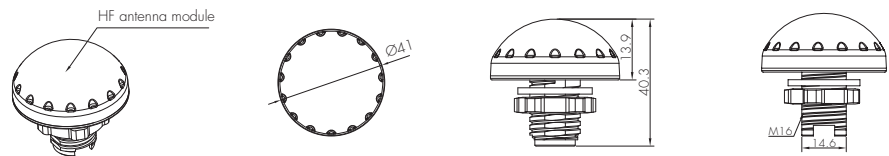

**K. SAM22**

HF sensor head  
 Flush mount  
 The cable length is around 65cm.

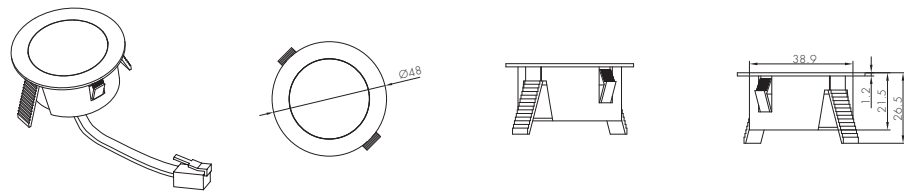

**L. SAM23**

HF sensor head  
 Photocell advance™  
 Daylight sensor  
 For highbay application  
 The cable length is around 30cm.

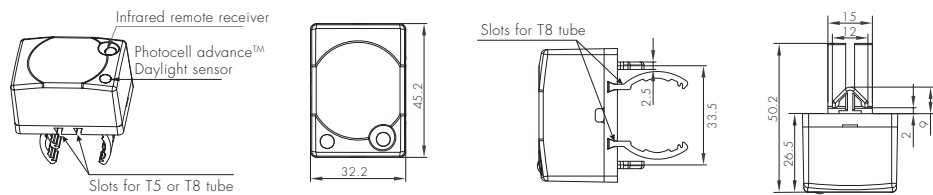

**Detection Pattern**

**SAM23**

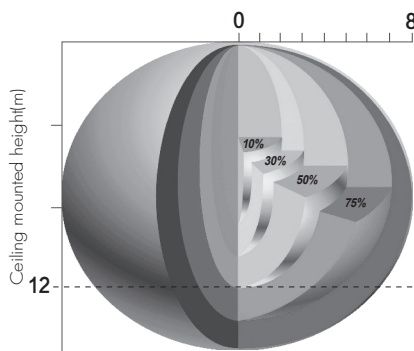

Ceiling mounted detection pattern (m)

**SAM20 / SAM21 / SAM22**

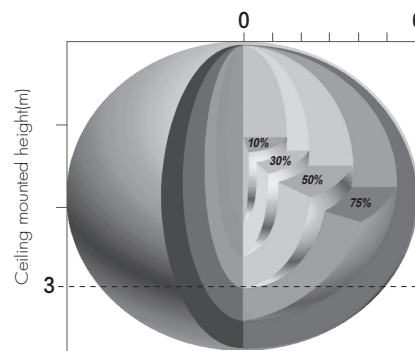

Ceiling mounted detection pattern (m)

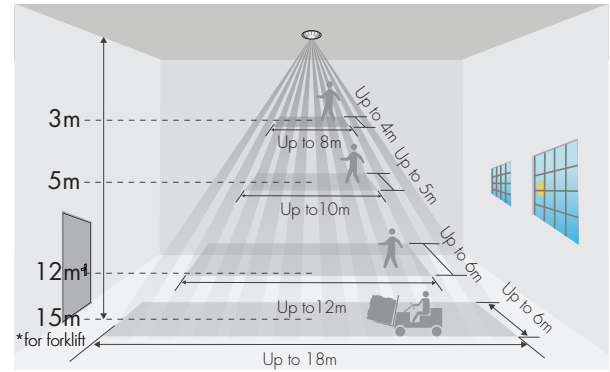
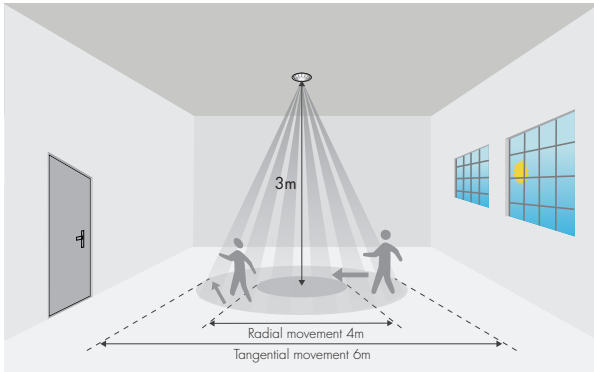

### HIR11 (High-bay)



**HIR11: High-bay lens detection pattern for forklift @ Ta = 20°C**  
(Recommended installation height **10m-15m**)

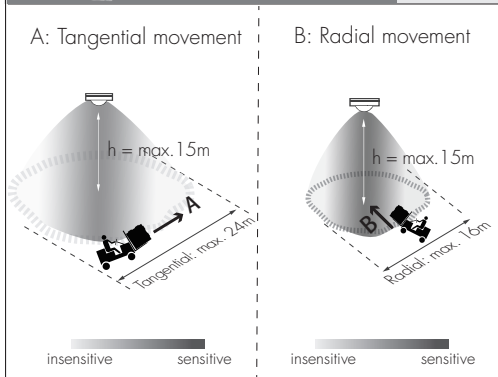

Mount height	Tangential (A)	Radial (B)
10m	max 380m <sup>2</sup> (Ø = 22m)	max 201m <sup>2</sup> (Ø = 16m)
11m	max 452m <sup>2</sup> (Ø = 24m)	max 201m <sup>2</sup> (Ø = 16m)
12m	max 452m <sup>2</sup> (Ø = 24m)	max 201m <sup>2</sup> (Ø = 16m)
13m	max 452m <sup>2</sup> (Ø = 24m)	max 177m <sup>2</sup> (Ø = 15m)
14m	max 452m <sup>2</sup> (Ø = 24m)	max 133m <sup>2</sup> (Ø = 13m)
15m	max 452m <sup>2</sup> (Ø = 24m)	max 113m <sup>2</sup> (Ø = 12m)



**HIR11: High-bay lens detection pattern for single person @ Ta = 20°C**  
(Recommended installation height **2.5m-12m**)

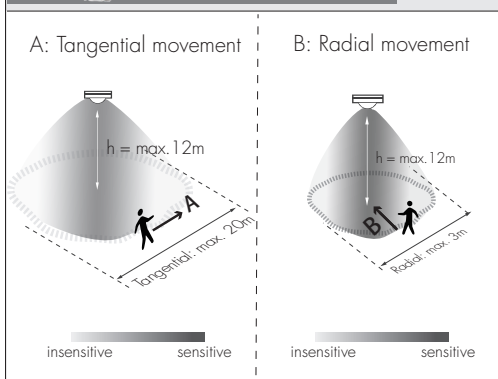

Mount height	Tangential (A)	Radial (B)
2.5m	max 50m <sup>2</sup> (Ø = 8m)	max 7m <sup>2</sup> (Ø = 3m)
6m	max 104m <sup>2</sup> (Ø = 11.5m)	max 7m <sup>2</sup> (Ø = 3m)
8m	max 154m <sup>2</sup> (Ø = 14m)	max 7m <sup>2</sup> (Ø = 3m)
10m	max 227m <sup>2</sup> (Ø = 17m)	max 7m <sup>2</sup> (Ø = 3m)
11m	max 269m <sup>2</sup> (Ø = 18.5m)	max 7m <sup>2</sup> (Ø = 3m)
12m	max 314m <sup>2</sup> (Ø = 20m)	max 7m <sup>2</sup> (Ø = 3m)



## Dimming Interface Operation Notes

### Switch-Dim

The provided Switch-Dim interface allows for a simple dimming method using commercially available non-latching (momentary) wall switches. Up to 64 LED drivers may be connected to one switch. Detailed Push switch configurations can be set on Koolmesh app.

Switch Function	Action	Descriptions
Push switch	Short press (<1 second) * Short press has to be longer than 0.1s, or it will be invalid.	- Turn on/off - Recall a scene - Turn on only - Exit manual mode - Turn off only - Do nothing
	Double push	- Turn on only - Exit manual mode - Turn off only - Do nothing - Recall a scene
	Long press (≥1 second)	- Dimming - Colour tuning - Do nothing
Simulate sensor	/	- Upgrade a normal on/off motion sensor to a Bluetooth controlled motion sensor

## Additional Information / Documents

1. Regarding precautions for LED driver installation and operation, please kindly refer to [www.hytronik.com/download->knowledge->LED Drivers - Precautions for Product Installation and Operation](http://www.hytronik.com/download->knowledge->LED%20Drivers%20-%20Precautions%20for%20Product%20Installation%20and%20Operation)
2. To learn more about detailed product features/functions, please refer to [www.hytronik.com/download->knowledge->Introduction of App Scenes and Product Functions](http://www.hytronik.com/download->knowledge->Introduction%20of%20App%20Scenes%20and%20Product%20Functions)
3. Regarding precautions for Bluetooth product installation and operation, please kindly refer to [www.hytronik.com/download->knowledge->Bluetooth Products - Precautions for Product Installation and Operation](http://www.hytronik.com/download->knowledge->Bluetooth%20Products%20-%20Precautions%20for%20Product%20Installation%20and%20Operation)
4. Data sheet is subject to change without notice. Please always refer to the most recent release on [www.hytronik.com/products/bluetooth technology->Bluetooth Drivers](http://www.hytronik.com/products/bluetooth%20technology->Bluetooth%20Drivers)
5. Regarding Hytronik standard guarantee policy, please refer to [www.hytronik.com/download->knowledge->Hytronik Standard Guarantee Policy](http://www.hytronik.com/download->knowledge->Hytronik%20Standard%20Guarantee%20Policy)