

PIR Standalone Motion Sensor with  Bluetooth® Mesh

HYTRONIK®

HBIR29/SV HBIR29/SV/R HBIR29/SV/H HBIR29/SV/RH
 Low-bay Reinforced Low-bay High-bay Reinforced High-bay

 Bluetooth®   CB IP20 RED  EMC  CE

Product Description

HBIR29/SV is a Bluetooth PIR standalone motion sensor with 80mA DALI power supply built in, which can control up to 40 LED drivers. It is ideal for typical indoor applications such as office, classroom, healthcare and other commercial areas. Meanwhile, all commissioning and settings can be done via SILVAIR app.



Functions and Features

- Bluetooth® mesh compliant
- 80mA DALI broadcast output for up to 40 LED drivers
- Surface mount kit available as accessory
- PIR occupancy detection with 2 types of blind inserts / blanking plates
- Daylight harvesting

(Note: The component may not be suitable for daylight harvesting usage due to not being precise in lux measurements. Please only use daylight harvesting feature if user conducted field tests and accepts the the tolerance level.)

- Scene control, Task tuning (0-100%)
- Compact form factor
- Works with DALI LED drivers
- Autonomous sensor-based control
- OTA firmware upgrade
- Continuous dimming
- Individual/group addressing
- Decentralized control (no single point of failure)
- User-friendly design for installation
- High bay version available (up to 1.5m in height)
- 5-years warranty

 **EnOcean**
Self-powered IoT



Fully support EnOcean self-powered switch module PTM215B (HBES01/W & HBES01/B)



 Download on the APP Store

The access to SilvaIR apps

mobile app: SilvaIR on the App Store

web app: platform.silvaIR.com

Technical Specifications

Bluetooth Transceiver	
Operation frequency	2.4 GHz - 2.483 GHz
Transmission power	4 dBm
Range (Typical indoor)	10~30m
Protocol	 Bluetooth® Mesh

Input & Output Characteristics	
Operating voltage	220~240VAC 50/60Hz
Max input current	10mA
Stand-by power	<0.65W (Empty load)
Switched power	Max. 40 devices, 80mA
Warming-up	5s
Tc max	60°C
Lux range	1-1,000lux Tolerance +/- 20%

Sensor Data	
Sensor Model	PIR detection
HBIR29/SV	Installation Height : 6m Detection Range(Ø) : 9m
HBIR29/SV/R	Installation Height : 6m Detection Range(Ø) : 10m
HBIR29/SV/H	Installation height: 1.5m (forklift) 1.2m (person) Detection range (Ø): 24m
HBIR29/SV/RH	Installation height: 20m (forklift) 1.2m (person) Detection range (Ø): 40m
Detection angle	360°
Standard compliance	EN300328, EN301489-1, EN301489-17, EN62479, EN55015, EN61547, EN60669-1, EN60669-2-1, EN62493

* For more details of detection range, please refer to "detection pattern" section.

Environment	
Operation temperature	Ta: -20°C ~ +50°C
Operation humidity (RH%)	10%~90% (Non-condensing)
Storage temperature (°C)	-40°C~+70°C
Storage humidity (RH%)	10%~90% (Non-condensing)
IP rating	IP20

Mechanical Structure & Dimensions

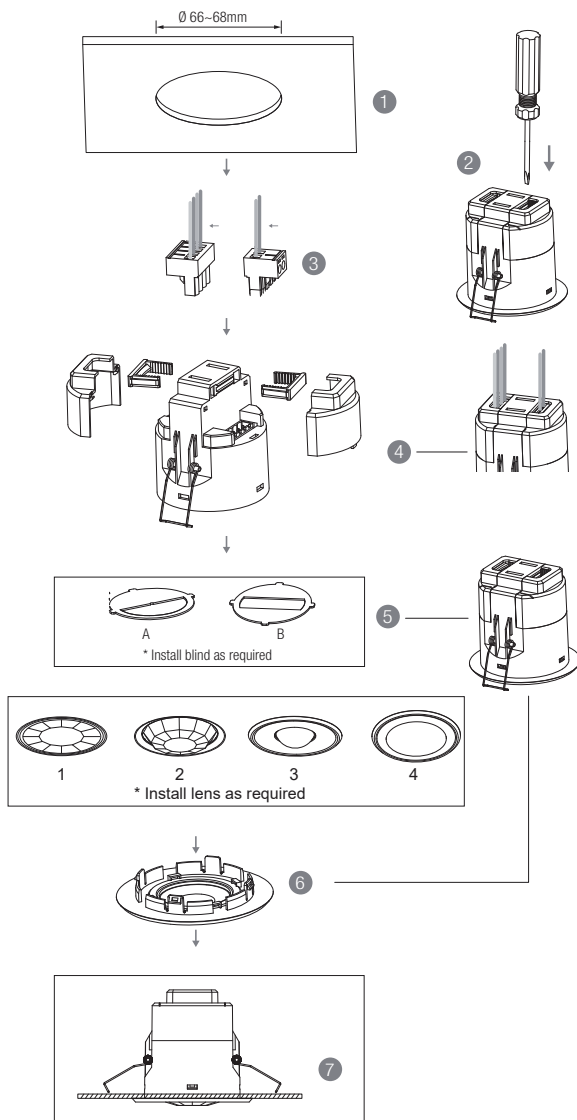

1. Ceiling (drill hole \varnothing 66~68mm)
2. Carefully prise off the cable clamps.
3. Make connections to the pluggable terminal blocks.
4. Insert plug connectors and secure using the provided cable clamps, then clip terminal covers to the base.
5. Fit detection blind (if required) and desired lens.
6. Clip fascia to body.
7. Bend back springs and insert into ceiling.

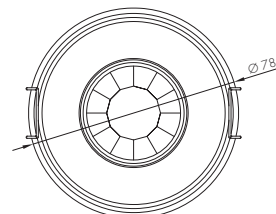

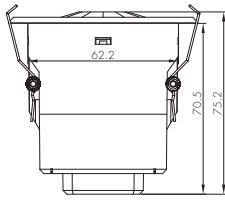

HBR29/SV

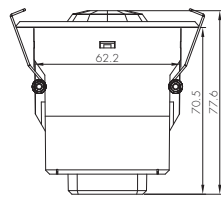

HBR29/SV/R

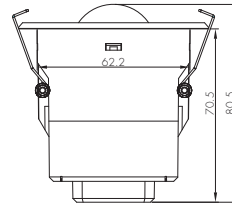

HBR29/SV/H

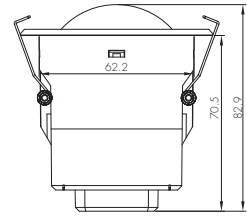

HBR29/SV/RH

Wire Preparation

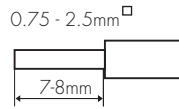

Pluggable screw terminal. It is recommended to make connections to the terminal before fitting to the sensor.

Detection Pattern & Optional Accessories

1. HBR29/SV (Low-bay)



HBR29/SV: Low-bay flat lens detection pattern for single person @ Ta = 20°C

(Recommended ceiling mount installation height 2.5m-6m)

A: Tangential movement	B: Radial movement	Mount height	Tangential (A)	Radial (B)
		2.5m	max 50m ² (Ø = 8m)	max 13m ² (Ø = 4m)
		3m	max 64m ² (Ø = 9m)	max 13m ² (Ø = 4m)
		4m	max 38m ² (Ø = 7m)	max 13m ² (Ø = 4m)
		5m	max 38m ² (Ø = 7m)	max 13m ² (Ø = 4m)
		6m	max 38m ² (Ø = 7m)	max 13m ² (Ø = 4m)

Optional Accessory --- Ceiling/Surface Mount Box: HA03

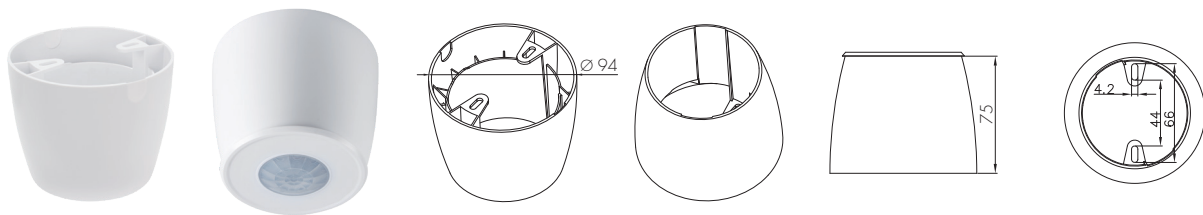

Optional Accessory --- Blind Insert for Blocking Certain Detection Angles

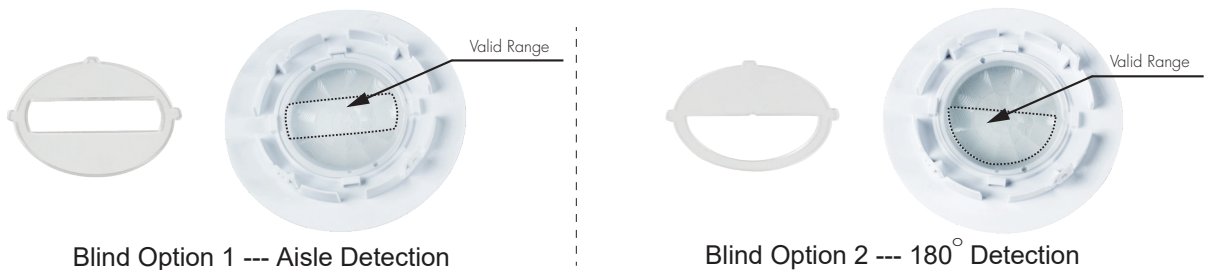

2. HBIR29/SV/R (Reinforced Low-bay)



HBIR29/SV/R: Low-bay convex lens detection pattern for **single person** @ Ta = 20°C

(Recommended ceiling mount installation height **2.5m-6m**)

A: Tangential movement	B: Radial movement	Mount height	Tangential (A)	Radial (B)
		2.5m	max 79m ² (∅ = 10m)	max 20m ² (∅ = 5m)
		3m	max 79m ² (∅ = 10m)	max 20m ² (∅ = 5m)
		4m	max 64m ² (∅ = 9m)	max 20m ² (∅ = 5m)
		5m	max 50m ² (∅ = 8m)	max 20m ² (∅ = 5m)
		6m	max 50m ² (∅ = 8m)	max 20m ² (∅ = 5m)

Optional Accessory --- Ceiling/Surface Mount Box: HA03

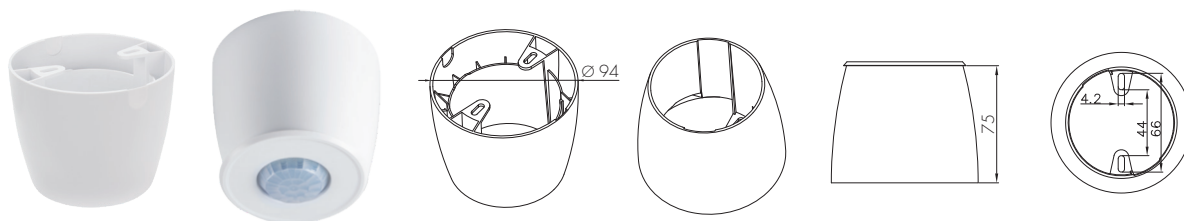

Optional Accessory --- Blind Insert for Blocking Certain Detection Angles

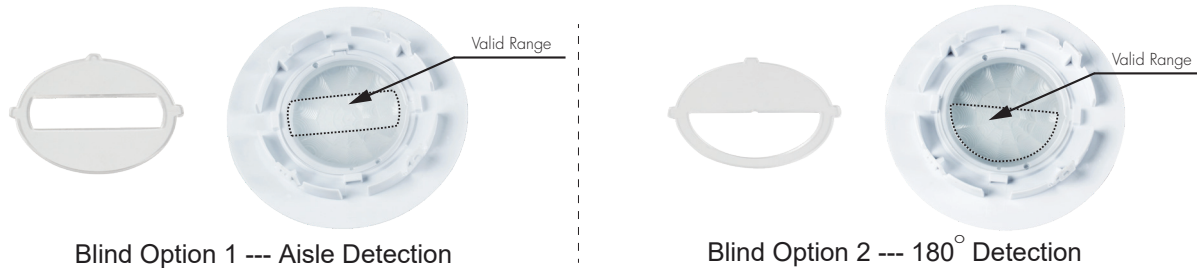

Blind Option 1 --- Aisle Detection

Blind Option 2 --- 180° Detection

3. HBIR29/SV/H (High-bay)



HBIR29/SV/H: High-bay lens detection pattern for forklift @ Ta = 20°C

(Recommended ceiling mount installation height **10m-15m**)

A: Tangential movement

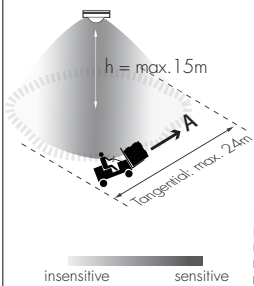

B: Radial movement

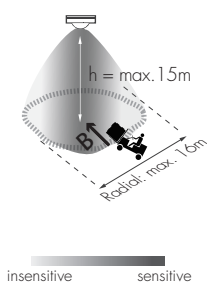

Mount height	Tangential (A)	Radial (B)
10m	max 380m ² (Ø = 22m)	max 201m ² (Ø = 16m)
11m	max 452m ² (Ø = 24m)	max 201m ² (Ø = 16m)
12m	max 452m ² (Ø = 24m)	max 201m ² (Ø = 16m)
13m	max 452m ² (Ø = 24m)	max 177m ² (Ø = 15m)
14m	max 452m ² (Ø = 24m)	max 133m ² (Ø = 13m)
15m	max 452m ² (Ø = 24m)	max 113m ² (Ø = 12m)



HBIR29/SV/H: High-bay lens detection pattern for single person @ Ta = 20°C

(Recommended ceiling mount installation height **2.5m-12m**)

A: Tangential movement

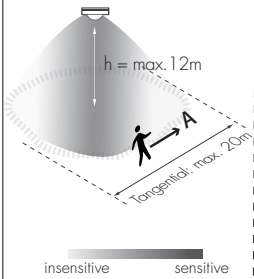

B: Radial movement

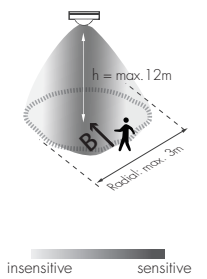

Mount height	Tangential (A)	Radial (B)
2.5m	max 50m ² (Ø = 8m)	max 7m ² (Ø = 3m)
6m	max 104m ² (Ø = 11.5m)	max 7m ² (Ø = 3m)
8m	max 154m ² (Ø = 14m)	max 7m ² (Ø = 3m)
10m	max 227m ² (Ø = 17m)	max 7m ² (Ø = 3m)
11m	max 269m ² (Ø = 18.5m)	max 7m ² (Ø = 3m)
12m	max 314m ² (Ø = 20m)	max 7m ² (Ø = 3m)

Optional Accessory -- Ceiling/Surface Mount Box: HA03

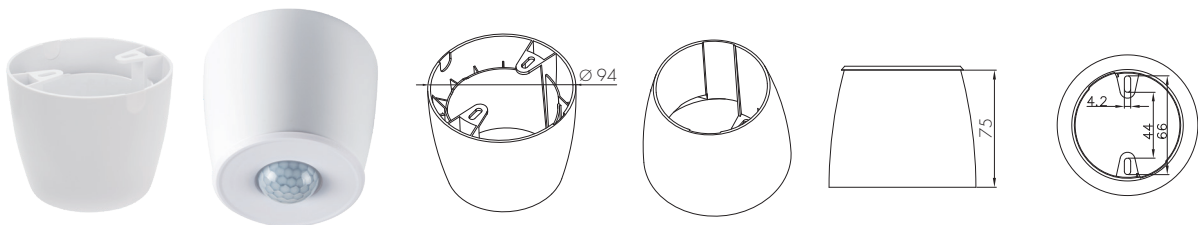

Optional Accessory -- Blind Insert for Blocking Certain Detection Angles

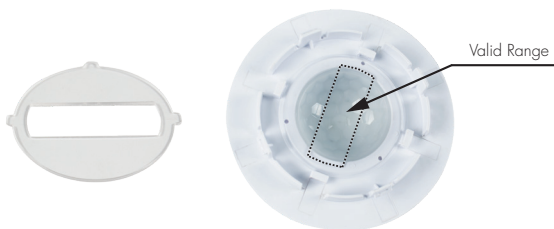

Blind Option 1 --- Aisle Detection

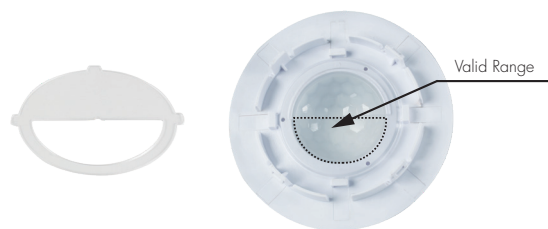

Blind Option 2 --- 180° Detection

4. HBIR29/SV/RH (Reinforced High-bay with 3-Pyro)



HBIR29/SV/RH: Reinforced high-bay lens detection pattern for **forklift** @ $T_a = 20^\circ\text{C}$
 (Recommended ceiling mount installation height **10m-20m**)

A: Tangential movement	B: Radial movement	Mount height	Tangential (A)	Radial (B)
		10m	max 346m ² (Ø = 21m)	max 177m ² (Ø = 15m)
		11m	max 660m ² (Ø = 29m)	max 177m ² (Ø = 15m)
		12m	max 907m ² (Ø = 34m)	max 154m ² (Ø = 14m)
		13m	max 962m ² (Ø = 35m)	max 154m ² (Ø = 14m)
		14m	max 1075m ² (Ø = 37m)	max 113m ² (Ø = 12m)
		15m	max 1256m ² (Ø = 40m)	max 113m ² (Ø = 12m)
		20m	max 707m ² (Ø = 30m)	max 113m ² (Ø = 12m)



HBIR29/SV/RH: Reinforced high-bay lens detection pattern for **single person** @ $T_a = 20^\circ\text{C}$
 (Recommended ceiling mount installation height **2.5m-12m**)

A: Tangential movement	B: Radial movement	Mount height	Tangential (A)	Radial (B)
		2.5m	max 38m ² (Ø = 7m)	max 7m ² (Ø = 3m)
		6m	max 154m ² (Ø = 14m)	max 7m ² (Ø = 3m)
		8m	max 314m ² (Ø = 20m)	max 7m ² (Ø = 3m)
		10m	max 531m ² (Ø = 26m)	max 13m ² (Ø = 4m)
		11m	max 615m ² (Ø = 28m)	max 13m ² (Ø = 4m)
		12m	max 707m ² (Ø = 30m)	max 13m ² (Ø = 4m)

Optional Accessory -- Ceiling/Surface Mount Box: HA03

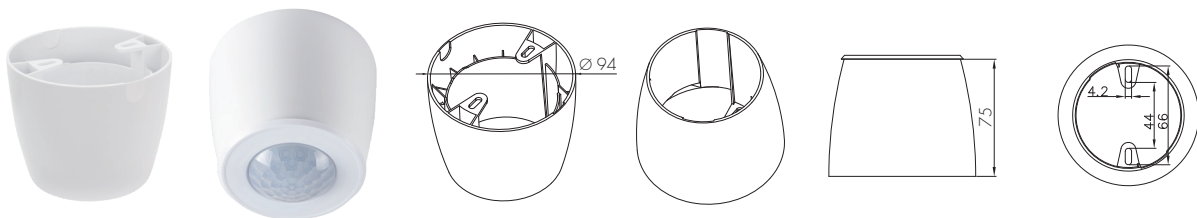

Wiring Diagram

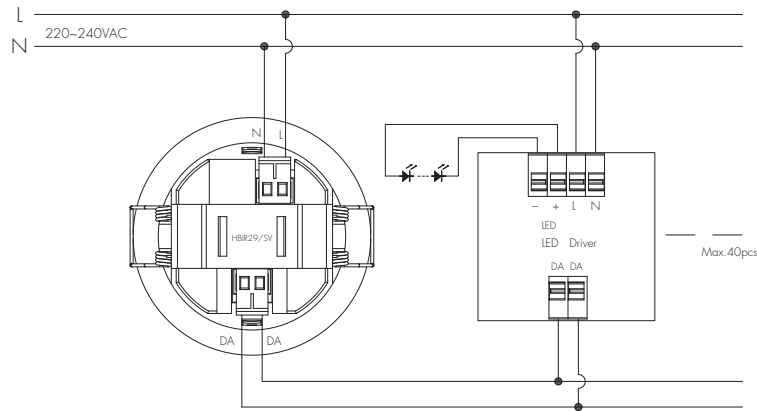

Mesh Factory Reset

The device HBR29/SV can be reset by placing a strong magnet (e.g. N38 neodymium magnet, $d=10\text{mm} \times h=4\text{mm}$) near the sensor lens for 5 seconds. Once the factory reset is done successfully, the luminaire flashes and then permanent on, then the device is being able to be re-commissioned by SILVAIR app.

To Reprovision

Place a strong magnet on the site of the Reset/Hall effect sensor (see diagram 4 below). To trigger the reset the magnet must be held in position for 5 seconds.

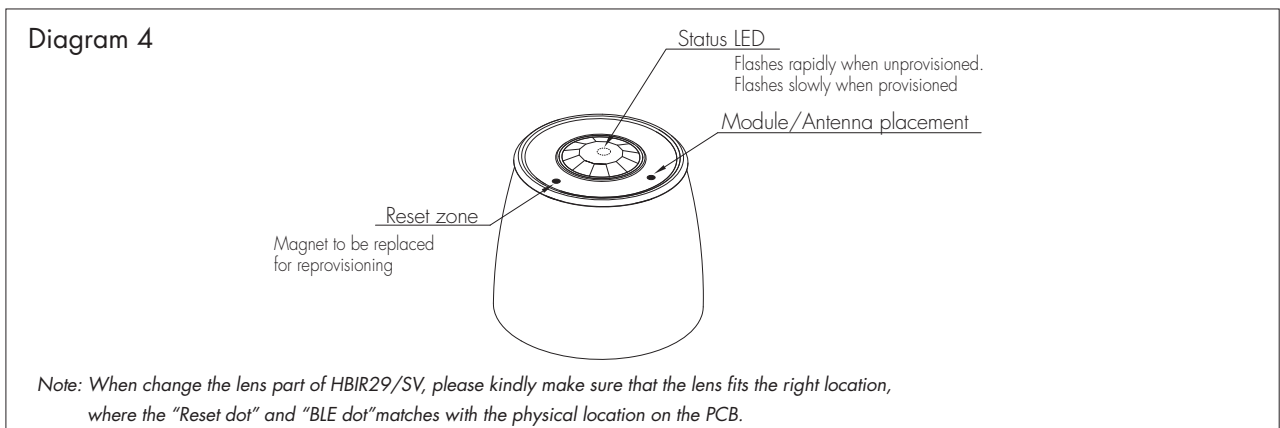

Status LED blinking Sequence		
HBR29/SV Unprovisioned	30ms ON	300ms OFF
HBR29/SV Provisioned	15ms ON	2,000ms OFF
Factory reset	500ms ON	1,000ms OFF
Factory reset (initial burst)	100ms ON	1,000ms OFF
MESH package received	30ms ON	50ms OFF
Attention (from network)	500ms ON	500ms OFF

Small silicon water-proof gasket dimension(size:mm)

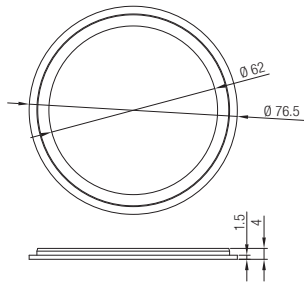

Big silicon water-proof gasket dimension(size:mm)

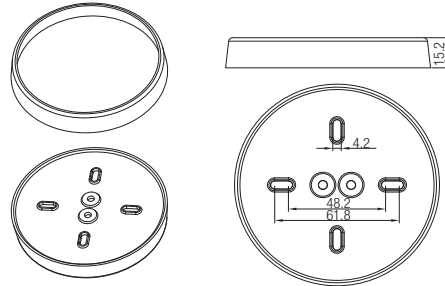

Supported Bluetooth Mesh Models

Bluetooth mesh models servers	
Mesh model generic default transition time server	Mesh model sensor server
Mesh model generic level server	Mesh model sensor setup server
Mesh model generic onoff server	
Mesh model generic power on off server	
Mesh model generic power on off setup server	
Mesh model light LC server	
Mesh model light LC setup server	
Mesh model light lightness server	
Mesh model light lightness setup server	

Placement Guide and Typical Range

Smart Phone to Device Range

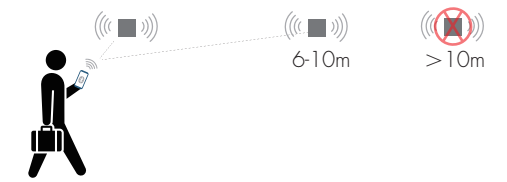

The smart device with the App installed will have a typical range of 10m, but varies from device to device. During commissioning, the installer will need to be in range of the devices when searching for devices to add to the network.

Once the devices have been added to the network via the App, the devices will start communicating within the wireless mesh. This means that once the network is complete, all devices are accessible from the smart device when in a 20m range of a single point.

Additional Information / Documents

1. Regarding precautions for PIR Sensors installation and operation, please kindly refer to [www.hytronik.com/download ->knowledge ->PIR Sensors - Precautions for Product Installation and Operation](http://www.hytronik.com/download->knowledge->PIR%20Sensors%20-%20Precautions%20for%20Product%20Installation%20and%20Operation)
2. Data sheet is subject to change without notice. Please always refer to the most recent release on [www.hytronik.com/products/bluetooth technology ->Partnership](http://www.hytronik.com/products/bluetooth%20technology->Partnership)
3. Regarding Hytronik standard guarantee policy, please refer to [www.hytronik.com/download ->knowledge ->Hytronik Standard Guarantee Policy](http://www.hytronik.com/download->knowledge->Hytronik%20Standard%20Guarantee%20Policy)