

# SensorDIM<sup>®</sup> ballast overview

These electronic ballasts are specially designed to work with sensors (motion sensor, infrared sensor, light sensor, sound sensor etc.), which give out 220-240v continuous output signal. Upon receiving the signal, the ballasts work on full power; when the signal passes out, the ballast works on stand-by mode, at low light output and power consumption.

It takes 0.5 second for the ballast to shift from stand-by brightness to full power; and 2 seconds from full power to stand-by brightness. This soft transition is friendly and comfortable to human eyes.

The ballast compensates the filament current when the fluorescent tubes are working on stand-by dimming mode, this device has secured the fluorescent tube immediately reaching its max. brightness on receiving of the motion signal, as well as the life span of fluorescent tubes no matter the fluorescent tube works constantly in dimming status, or frequently shifted between full power and dimming status.

**The stand-by light output and power consumption can be pre-set by choosing the desired combination of the encoded programmed switch-**

●:ON ○:OFF



Recommendation

	1	2	3	% of full power
I	○	○	○	100%
II	●	○	○	50%
III	●	●	○	25%
IV	●	●	●	10%

●:ON ○:OFF



Recommendation

	1	2	3	% of full power
I	○	○	○	100%
II	●	○	○	50%
III	●	●	○	25%
IV	●	●	●	10%

## Wiring schematic

To connect 1 ballast with 1 sensor, the wiring should



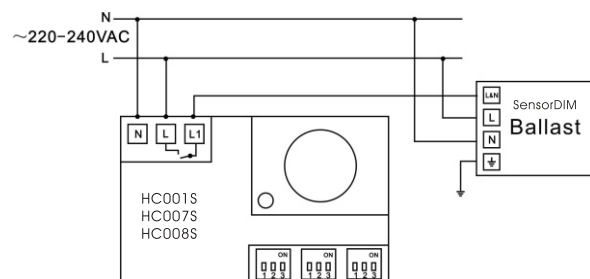



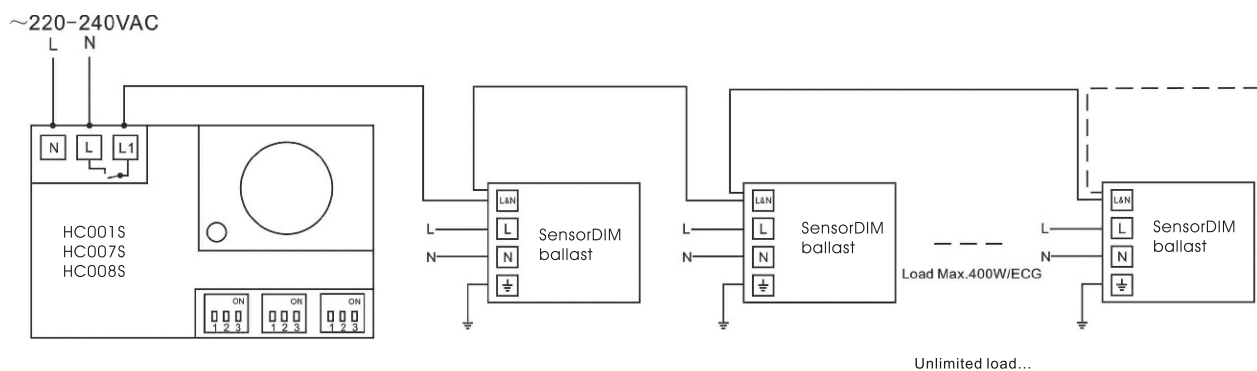



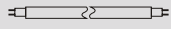
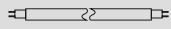
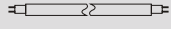
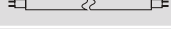
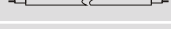

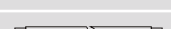

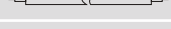
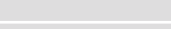









follow the below schematic:



To connect several ballast with 1 sensor, the wiring should follow the below schematic:

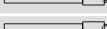

All HYTRONIK sensorDIM ballast are listed in the following table. Please visit our web for detailed technical specification of each model.

Control gear category	Lamp type		Wattage	Groups of LEDs	Model	Cert.
LED sensorDIM driver (Page 47)	LED	350mA	Max. 18w	1x	HE1018-1	Semko CE,EMC
		500mA	Max. 18w	1x	HE1018-1	Semko CE,EMC
		750mA	Max. 18w	1x	HE1018-1	Semko CE,EMC
		1000mA	Max. 18w	1x	HE1018-1	Semko CE,EMC
HF sensorDIM ballast  (Please refer to our web for detailed tech, spcification)	T5		14/21/28/35	1x	HB0135-1	Semko CE,EMC
	T5		35	1x	HB0135-2	Semko CE,EMC
	T5		8/13	1x	HB0116-1	Semko CE,EMC
	T5		24/39	1x	HB0142-1	Semko CE,EMC
	T5		14/21/28/35	2x	HB0235-1	Semko CE,EMC
	T5		24/39	2x	HB0242-1	Semko CE,EMC
	T5		49	2x	HB0249-1	Semko CE,EMC
	T5		54	2x	HB0254-1	Semko CE,EMC
	T5		80	2x	HB0280-1	Semko CE,EMC
	T8		18/30/36	1x	HB0142-1	Semko CE,EMC
	T8		18/30/36	2x	HB0242-1	Semko CE,EMC
	T8		58	2x	HB0254-1 /858	Semko CE,EMC
	T5C		22/40	1x	HB0142-1	Semko CE,EMC
	T5C		22/40, 22+40	2x	HB0242-1	Semko CE,EMC
	TC-DD		28	1x	HB0142-1	Semko CE,EMC
	TC-DD		38	1x	HB0142-1/DD38	Semko CE,EMC
	TC-DD		10/16	1x	HB0116-1	Semko CE,EMC
	TC-DD		28	2x	HB0242-1	Semko CE,EMC
	TC-DD		38	2x	HB0242-1/DD38	Semko CE,EMC
	TC-DEL		10/13/18	1x	HB0116-1	Semko CE,EMC
	TC-DEL		10/13/18	2x	HB0216-1	Semko CE,EMC
	TC-DEL		26	1x	HB0142-1	Semko CE,EMC
	TC-DEL		26	2x	HB0242-1	Semko CE,EMC
	TC-TEL		26/32/42	1x	HB0142-1	Semko CE,EMC
	TC-TEL		26/32/42	2x	HB0242-1	Semko CE,EMC
	TC-L		7/9/11	1x	HB0116-1	Semko CE,EMC
	TC-L		18/24/36/40	1x	HB0142-1	Semko CE,EMC
	TC-L		55	2x	HB0254-1/L55	Semko CE,EMC
TC-L		18/24/36/40	2x	HB0242-1	Semko CE,EMC	
TC-F		18/24/36/40	1x	HB0142-1	Semko CE,EMC	
TC-F		18/24/36/40	2x	HB0242-1	Semko CE,EMC	